



**RESCUE**  
**TECH**











540° Belay .....	42
ACCESS™ Lifeline .....	3, 4
Air Cart .....	104
Anchor Plates .....	53
Arizona Vortex .....	60
Ascenders .....	47, 48
Backboards .....	72
Bags, Equipment .....	80, 81, 82
Bags, Gear .....	83
Bags, Rope .....	11, 12
Books, Rescue .....	119, 120, 121
Books, Water Rescue .....	119
Boots .....	93
Cable Umbilical .....	102
Carabiners, Aluminum .....	32, 33
Carabiners, Steel .....	29, 30, 31, 32
Command Board .....	107
Communication Equipment .....	101, 109
Confined Space Rescue Kits .....	35, 36, 38
CON-SPACE .....	101, 102
Cord, Prusik .....	5
CORONA™ Escape Belt .....	20
Decon Stretcher .....	72
Descenders, Escape .....	50
Descenders, Figure 8 .....	50, 51
Descenders, Rack-type .....	52
Dive Mask .....	96
Drag Hook .....	54
Dry Suits .....	85, 86
Duffel Bags .....	82, 83
Edge Guard .....	9
Edge Protection .....	9, 10
Edge Roller .....	9
E-FLARE™ .....	119
EGRESS™ Escape Rope .....	13, 14
Equipment Packs .....	80, 81, 82
Escape / Search Bag .....	12
Escape Belt .....	20, 21
Escape Anchors .....	18
Escape Kits .....	13, 14
Etrier .....	58
EXTRACTOR™ CSR Kits .....	35
Fall Protection Devices .....	61, 62
Fall Protection Harness .....	25
Fins .....	94
Firefighters' Rescue Slings/ Kits .....	17, 19
Fire Resistant Manikin .....	77
Flexible Stretcher .....	67, 74, 75
Gas Monitors .....	108
Gibbs Ascender .....	47

## INDEX

Gloves, Dive .....	93
Gloves, Rescue/Rappel .....	111
Harness, Belt .....	20, 21
Harness, Chest .....	26, 27
Harness, Confined Space .....	22, 23
Harness, Fire Resistant .....	20, 21
Harness, Rescue .....	22 - 27
Harness, Riggers .....	24, 25
Harness, Victim .....	27, 28
Hauling Kits .....	34, 35, 39
Headlamps .....	116, 117, 118
Helmets, Rescue .....	113, 114, 115
Helmets, Water .....	91
Hoist, Tripod .....	61, 62
I'D™ .....	49
Kits, Rescue .....	36 - 40
KIWI™ Helmets .....	113, 114
Knee Pads .....	112
Knives .....	97, 110
Ladder, Webbing .....	58
Landing Zone Kit .....	119
Lanyards .....	20, 23, 63, 64
LARKIN Frame .....	60
Lifeline, Vertical .....	8
Lights, Dive .....	117
Lights, Handheld .....	118
Lights, Strobe .....	98, 119
Links .....	32
Litter Bridles .....	71
Litter Trailer .....	65
Litter Wheel .....	70
Load Release Strap .....	55
LSP Halfback .....	74
Manikins, Training .....	76, 77, 78, 79
Mini-Haul Kit .....	34
Monitors .....	108
Packs .....	80, 81, 82
Patient Handling .....	65 - 75
Personal Flotation Devices .....	89, 90
PROBE™ Search Line .....	15
Prusik Cord .....	5
Prusik, Sewn .....	5
Pulleys, Aluminum .....	41, 42, 43, 44
Pulleys, Knot Passing .....	44
Pulleys, PMP .....	42, 43
Pulleys, Stainless Steel .....	43, 44, 45, 58
Quadlock Carabiner .....	29
Radio Harness .....	109
Raft Kit .....	37
RAMFAN™ .....	103, 104
Reeves Sleeve .....	74

Rescue 8 Descender .....	50, 51
Rescue Cradle .....	28
Rigging Hardware .....	32, 52, 54
Rigging Plate .....	53
Rigging Slings .....	37, 55, 56
RIT Drag Bags .....	17
RIT Kits .....	13, 14, 15, 16, 17
River Board .....	94
Rope & Equipment Bags .....	11
Rope Accessories .....	7, 8
Rope Pad .....	9
Rope, ACCESS™ Lifeline .....	3, 4
Rope, Dynamic .....	6
Rope, Fire Resistant .....	13, 14, 15
Rope, NFPA .....	3, 4, 5, 13
Rope, Polypropylene .....	5, 100
Rope, Rescue .....	3, 4
Rope, Swaged .....	6
RUTH LEE™ Manikins .....	76, 77, 78
Scaffold Hooks .....	31
SEARCHCAM® .....	106
Search Kits .....	15, 16, 17
Seat Harness .....	26, 27
Shock Absorber .....	57, 63
Simulaids™ .....	79
SKED™ .....	75
SKYHOOK™ Winch .....	59
Slings .....	55, 56, 63, 64
Snorkel .....	96
SPIN-LOCK™ Rescue Kits .....	36
Stretchers, Basket .....	65, 66, 67, 68
Supplied Air Systems .....	104
Swivel .....	32
Throw Bags .....	99
Tower Harness .....	22, 24
Tower Rescue System .....	36
Tripod .....	60, 61, 62
VANGUARD™ Rescue Harness .....	22
Ventilation Equipment .....	103, 104
VISION STICK™ Rescue Video .....	105, 106
Water Rescue Equipment .....	85 - 100
Water Rescue Sled .....	94
Webbing .....	57
Webbing Ladder .....	58
Weight Vest, Manikin .....	76
Weight Vest, Personnel .....	77
Wetsuits .....	87, 88
Winch, Rescue .....	59
Winch, Tripod .....	61, 62
Wristlet .....	23

## NEW AND IMPROVED PRODUCTS\*

	Sewn Prusik Cord .....5		Mini Haul Kit .....34
	Hardware Marking Pens .....8		<b>Rope Access Set</b> ..... <b>37</b>
	<b>Multi-Unit Edge Roller</b> .....9		12' Raft Kit .....37
			Rescue Team Set .....38
			Z-Rig Haul Set .....39
	Rope Management Rollers...10		Double Foot Sling .....49
	Escape / Search Pouch .....12		<b>Escape 8</b> ..... <b>50</b>
	<b>Search Rope w/ Snap</b> ..... <b>15</b>		Rescue Rappel Rack .....52
			Skyhook Web Anchor .....59
			Lanyard "I" .....64
			Lanyard "V" .....64
	Searchline Master Kit ..... 17		Mule Litter Wheel .....70
	Window Rappel Anchor ..... 18		Cliik-Lock 2 Pc Patient Strap 73
	RIT Rescue Slings..... 19		Reeves Sleeve Drag .....74
	Navaho Harness ..... 24		<b>Bariatric Training Manikin</b> ..... <b>78</b>
	<b>Operator Harness</b> ..... <b>25</b>		Harness Equipment Pouch...84
	RD70 Carabiner ..... 29		Swiftwater Rescue Drysuit 85
	<b>Big Dan Carabiner</b> ..... <b>29</b>		Force 6 PFD ..... 89
			SearchCAM ..... 106
			Under Door Camera ..... 107
			GX2003 4-Gas Monitor ..... 108
			<b>Trench Rescue Book</b> ..... <b>121</b>

\*Partial Listing

Items shown are in BOLD characters

Dear Friends & Rescuers:

Another year has passed with major accomplishments here at RescueTECH. We have just completed a 900 sq ft. expansion of floor space to our warehouse. This allows us to more efficiently store the ever-increasing number of products that we manufacture and distribute.

In December 2007 we successfully completed our annual audit to ISO9001-2000. Now certified by SGS, RescueTECH continues to provide the highest quality service and products to Technical Rescuers.

Look at our new items, highlighted in the listing above, for more innovative products from RescueTECH. We continue to be proud of our alliances with many top international equipment manufacturers such as Ruth Lee, Con-Space, and International Safety Components. Through these partnerships, rescuers can expect the highest quality from their rescue products.

We look forward to serving you in this year and for years to come!

Glenn Newell, President / Owner  
and Staff of Rescue Technology



**RESCUE TECH**

www.rescuetechn1.com



# RescueTECH ACCESS™ Lifeline

A New Era Begins...

RescueTECH spent 35 years helping design some of the best known rescue ropes in the world. Now, we have used our knowledge to create a rope design that gives the best combination of all desired characteristics. By building the ropes from the “ground up”, we are able to provide a super-strong rope with low stretch and excellent flexibility and knotability. Our ropes actually handle better after 6 months of use than some new ropes from other manufacturers. We specifically address the issue of sheath slippage when constructing all of our top quality Rescue Ropes. Solution dyed color insures that colors won't run. All ropes of the same diameter will perform identically, making multi-rope systems much easier to control. Certified to NFPA 1983 and EN1891. Available in 11 color combinations.



# RescueTECH NFPA Life Safety Ropes



RESCUE TECH



## ACCESS Lifeline™ - STRIPES

Stock Number	Diameter		Color/Stripe	NFPA Tensile Strength*		WLL** (lbs.)	NFPA Rating	Wgt / 100 ft (lbs.)
	in.	mm		lbf.	kN			
5157xxxOR 5157xxxBL 5157xxxRD 5157xxxYE 5147xxxWR 5147xxxWB	7/16	11	Orange w/ Yellow Blue w/ Yellow Red w/ Yellow Yellow w/ Blue White w/ Red White w/ Blue	7,800	35	520	Light	5.4
5158xxxOR 5158xxxBL 5158xxxLG 5158xxxRD 5158xxxYE 5148xxxWR 5148xxxWB	1/2	13	Orange w/ Yellow Blue w/ Yellow Lime Green w/ Blue Red w/ Yellow Yellow w/ Blue White w/ Red White w/ Blue	10,000	46	667	General	7.0
5159xxxOR 5159xxxBL 5159xxxRD 5159xxxYE	5/8	14.5	Orange w/ Yellow Blue w/ Yellow Red w/ Yellow Yellow w/ Blue	11,465	51	764	General	

\* Calculated as 3 standard deviations from the average tensile strength.

\*\* WLL - Recommended Working Load (also known as Safe Working Load) is calculated using the NFPA 15:1 Safe Working Load Ratio. See page 9 for further information on WLL.

### 7/16" Color w/ Stripe

- 7/16" x 150'
- 7/16" x 200'
- 7/16" x 300'
- 7/16" x 600'

### 7/16" White w/ Stripe

- 7/16" x 150'
- 7/16" x 200'
- 7/16" x 300'
- 7/16" x 600'

### 1/2" Color w/ Stripe

- 1/2" x 150'
- 1/2" x 200'
- 1/2" x 300'
- 1/2" x 600'

### 1/2" White w/ Stripe

- 1/2" x 150'
- 1/2" x 200'
- 1/2" x 300'
- 1/2" x 600'

### 5/8" Color w/ Stripe

- 5/8" x 300'
- 5/8" x 600'

To create the part number substitute the length for the 'xxx'.



## TECHNote™

### Stripes vs. Solids

Different colors are very useful in distinguishing particular ropes during a rescue or training operation. The addition of stripes to ropes offers the rescuer the ability to see the movement of the rope. When two striped ropes are used side-by-side, the stripes act as index marks. If the stripes on the two ropes are not moving in relationship to each other, then the ropes are travelling at the same speed.

www.rescuetechn1.com



# RescueTECH

## NFPA Life Safety Ropes

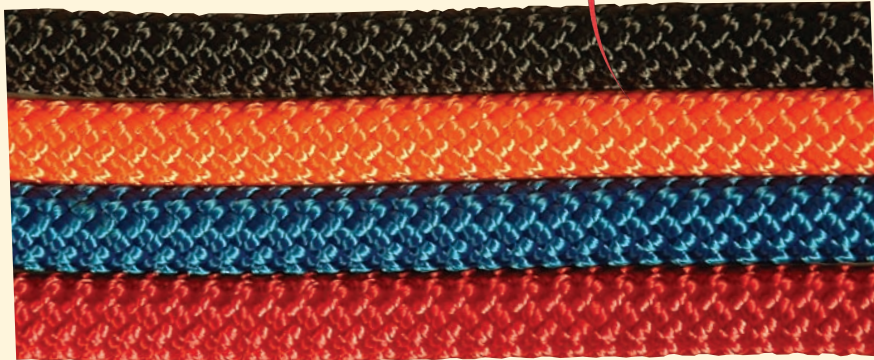

### ACCESS Lifeline™ - SOLIDS

Stock Number	Diameter		Color	NFPA Tensile Strength*		WLL** (lbs.)	NFPA Rating	Wgt / 100 ft (lbs.)
	in.	mm		lbf.	kN			
5156xxxORS 5156xxxBLS 5156xxxRDS 5156xxxBKS	3/8	9.5	Orange Blue Red Black	6,000	27	400	Light	4.7
5157xxxORS 5157xxxBLS 5157xxxRDS 5157xxxYES 5157xxxBKS 5157xxxODS	7/16	11	Orange Blue Red Yellow - <b>NEW</b> Black Olive Green - <b>NEW</b>	7,800	35	520	Light	5.4
5158xxxORS 5158xxxBLS 5158xxxRDS 5158xxxYES 5158xxxBKS 5158xxxODS	1/2	13	Orange Blue Red Yellow - <b>NEW</b> Black Olive Green - <b>NEW</b>	10,000	46	667	General	7.0

#### 3/8" Color

3/8" x 300'  
3/8" x 600'

#### 7/16" Color

7/16" x 150'  
7/16" x 200'  
7/16" x 300'  
7/16" x 600'

#### 1/2" Color

1/2" x 150'  
1/2" x 200'  
1/2" x 300'  
1/2" x 600'

To create the part number substitute the length for the 'xxx'.

\* Calculated as 3 standard deviations from the average tensile strength.

\*\* WLL - Recommended Working Load (also known as Safe Working Load) is calculated using the NFPA 15.1 Safe Working Load Ratio. See page 9 for further information on WLL.

### What to look for in Life Safety Ropes

**QUALITY** - RescueTECH operates under a quality control program that meets stringent ISO 9000 guidelines. We are certified to ISO-9001:2000 by SGS U.S. Testing Company, Inc., a leading independent international certifying organization. Also, most of the suppliers we work with, are certified to the ISO 9000 Standard. The ISO Standard ensures that our Quality Control and Quality Assurance programs meet stringent international guidelines.



**CONSTRUCTION** - 100% permanent solution dyed color in the polyester sheath with contrasting marker stripe. Superior flexibility, knotability and excellent resistance to abrasion that is up to four times greater than other kernmantle ropes.

**CONSISTENCY** - All ropes, in comparable sizes, have identical handling and performance characteristics. This is ideal for rescues requiring multiple ropes of different colors. RescueTECH ropes are designed to provide consistent performance throughout the life of the Lifeline.

**CERTIFICATION** - ALL RescueTECH General Use Lifelines, Personal Use Lifelines, and Escape Ropes meet or exceed current NFPA 1983 standards for construction, marking, and third party independent certification.

**ECONOMY** - The RescueTECH Rope's optimum blend of strength, flexibility, abrasion resistance, and load absorption creates the best rope for today's rescuers.



### 5mm TECH Cord

Tech Cord's small diameter and 5,000 pound strength are a result of using a unidirectional core of 100% Technora fibers and a tightly woven polyester sheath. Tech Cord is extremely strong and lightweight. Colors: Green Mix, Solid Black. Strength: 5,000 lbf.

23910500 Tech Cord x ft.

23910550 Tech Cord x 50 ft.

23910566 Tech Cord x 660 ft.

### ⚠ WARNING

Technical rescue and safety is potentially hazardous. Any person using equipment sold by RESCUE TECHNOLOGY in any manner is personally responsible for learning the proper techniques involved, and assumes all risks and accepts full and complete responsibility for any and all damages or injury of any kind, including death, which may result from the use of any RESCUE TECHNOLOGY equipment.

RESCUE TECH

www.rescuetechn1.com



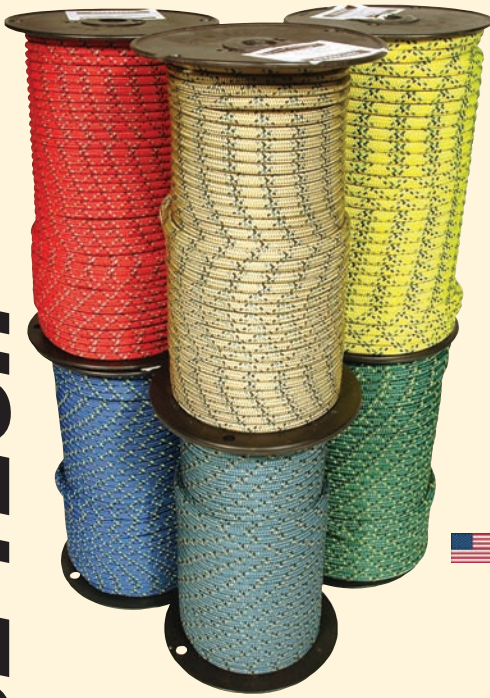

## RescueTECH Prusik Cords

Prusik cords with the same high quality and long wear design as our Rescue Ropes. Size selection should be based upon diameter of main line. Flexible cord that is both strong and highly resistant to abrasion, only one style of small diameter cord is produced. Available by the foot or in Spool Lengths: 6mm x 330 ft.; 7mm / 8mm/ 9mm x 200 ft.

	Diameter	Strength	Colors	Main Line	per ft.	Spool
5096000	6mm	1650 lbf.	Black, Blue Mix, Red Mix	7/16 - 1/2"	0.35	
5097000	7mm	2300 lbf.	Black, Teal Mix, Gold Mix	1/2 - 5/8"	0.43	
5098000	8mm	2900 lbf.	Black, Red Mix, Yellow Mix	1/2 - 5/8"	0.52	
5099000	9mm	3670 lbf.	Blue Mix, Yellow Mix	5/8"	0.63	

## TECHNote™

### Prusik Cord vs. Accessory Cord



What is the difference between prusik Cord and accessory cord? Generally there is no difference. The key is being able to provide a cord that has specifications and characteristics that meets the needs of the rescuer.



## RescueTECH Sewn Prusik



Our Product Development Department has worked hard to provide a durable Pre-Sewn 8mm prusik for use in rescue systems. Our heavy duty stitching uses thread that is 150% thicker/stronger than other brands. Since not all PMP's are equally sized, we have created 2 sizes of Short Prusiks to work with the Long Prusik. Testing shows that a single RescueTECH Sewn Prusik pulled on RescueTECH's ACCESS 1/2" Lifeline starts "clutching/slipping at a strength of 3,000 lbf". When pulled end-to-end the single loop strength exceeds 4,500 lbs. Marked with durable labeling to help product identification.



## 5/8" Hoisting Line

100% Multifilament polypropylene for a myriad of utility use. Ideal for hoisting equipment. Soft, supple, easy to grip. Strength: 4,000 lbf. WLL: 400 lbs. Diameter: 5/8". Color: Black.

751180162	16" for 2" PMP (Yellow)
751180182	18" for 2.5" - 3" PMP (Yellow)
751180224	22" Prusik (Red)

*\* Results may vary depending upon brand and condition/age of the main rope.*

230319001	Hoisting Line x ft.
230319101	Hoisting Line x 100'
230319501	Hoisting Line x 500'

**NOT FOR LIFE SAFETY USE.**

### ⚠ WARNING

Technical rescue and safety is potentially hazardous. Any person using equipment sold by RESCUE TECHNOLOGY in any manner is personally responsible for learning the proper techniques involved, and assumes all risks and accepts full and complete responsibility for any and all damages or injury of any kind, including death, which may result from the use of any RESCUE TECHNOLOGY equipment.

## TECHNote™

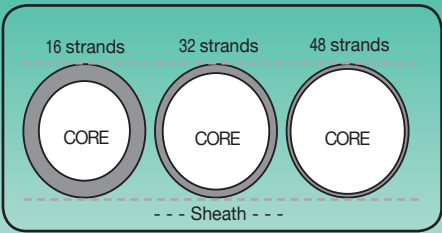

16 strands      32 strands      48 strands

CORE      CORE      CORE

--- Sheath ---

Sheath Thickness Diagram  
approximates actual sheath/core ratios.

### Number of Sheath Strands

The fewer strands that it takes to build the sheath means the sheath will be thicker and take longer to abrade. 16 strand sheath construction is effectively twice the thickness of the 32 strand sheaths and three times the thickness of 48 strand sheaths used in other static ropes. The key issue is whether the rope is able to maintain its handling characteristics. A 48 carrier braid may be smooth. But it is a relatively thin sheath and may not tie as easily as a 32 carrier sheath.





## RescueTECH Industrial Lifeline

### High Strength Swaged Eye

NFPA Life Safety ropes with a loop permanently swaged in the end. Kernmantle rope lasts an average of 6 times longer than twisted ropes. Swaging provides a high strength, permanent eye without the hassles of knots. Our testing shows that the loop strength in swaged ropes exceeds 90% of the NFPA required rope strength. Swaged ropes are complete with a protective thimble in the eye. 1/2" Lifeline WLL: 600 lbs. 7/16" Lifeline WLL: 300 lbs. Color: Orange or Blue. USE ONLY WITH ROPE GRABS DESIGNED FOR 1/2" KERNMANTLE ROPE.

1/2" Lifeline	Weight	7/16" Lifeline	Weight
598811050XX*	50 ft. 4.75 lbs.	598711100OR*	100 ft. 6.25 lbs.
598811075XX*	75 ft. 6.75 lbs.	598711150OR*	150 ft. 9.3 lbs.
598811100XX*	100 ft. 8.75 lbs.	59871200OR*	200 ft. 12.9 lbs.
598811150XX*	150 ft. 12.50 lbs.		
598811200XX*	200 ft. 16.75 lbs.		

\*\*Replace XX with "OR" (Orange) or BL (Blue)

Meets OSHA/ANSI Requirements for Vertical Lifeline. NFPA General Use Rope. Complies with NFPA 1983. Specify NFPA Labeling Requirements when ordering.

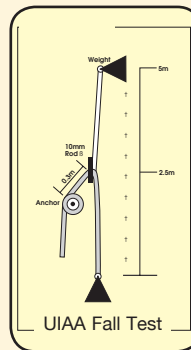

## RescueTECH Dynamic Rope

### Highest Quality / Load Absorption

A dynamic rescue rope manufactured for special applications when climbing above the rigging point. Superior construction with the highest quality standards. High fall rating, low impact loads, increased resistance to abrasion. Exceeds current UIAA and CE standards for dynamic ropes. Strength: 5,500 lbf. EN 892.

Stock Number	Dia. (mm)	Description	Length (ft.)	Length (meters)	UIAA Tested As	Weight / meter (gm)	UIAA Falls Survived	Max Impact Load (kN)	80 kg Elong (%)
5952165AM	11	Amber Mix	165	50	Single	75.2	14	9.62	4.8
5952165GR	11	Green Mix	165	50	Single	75.2	14	9.62	4.8

## TECHNote™

### ROPE END TERMINATION

The swaged end termination was developed after many years of research and development. Our process presses the entire length of the aluminum ferrule rather than multiple 5/16" rings along its length. The swaged termination grips the rope along the whole length of the swage to give excellent holding power and increase the user's ability to inspect the rope. This type of termination retains well over 90% of the NFPA required rope tensile strength. Our testing shows that nylon fibers stretch as a rope is loaded. This stretch causes a decrease in rope diameter that needs continuous contact to help compensate for this reduction and retain the rope's strength.



## RescueTECH Confined Space Retrieval Line

### With Forged Double Locking Snap

A retrieval line that interfaces with rope rescue systems. Our proprietary process creates a loop that exceeds the strength of a Figure 8 on a bight. The custom pressing die minimizes sharp edges often found on other swaged fittings. Manufactured from 1/2" NFPA rescue rope and forged double locking snaps. The nylon retrieval line meets the NFPA General Use Rope Standards and the ANSI Z-359.1 Retrieval Line Standards. WLL: 600 lbs. Rope Colors: Orange, Blue. USE ONLY WITH ROPE GRABS DESIGNED FOR 1/2" KERNMANTLE ROPE.

		Weight
598813100OR*	100' (Orange)	9 lbs.
598813100BL*	100' (Blue)	9 lbs.
598813150OR*	150' (Orange)	12.75 lbs.
598813150BL*	150' (Blue)	12.75 lbs.

\* Rope Certified NFPA 1983 compliant by UL. Meets Lifeline requirements for ANSI Z359.1, Retrieval Line requirement for OSHA 1910.146, and General Use Life Safety Rope Requirement for NFPA 1983.

## RescueTECH Double-End Industrial Lifeline

### High Strength Swaged Eye

1/2" NFPA Rescue Rope with swaged loops on each end. Color: Orange. WLL: 600 lbs. USE ONLY WITH ROPE GRABS DESIGNED FOR 1/2" KERNMANTLE ROPE.

		Weight
598812075OR*	75 ft.	7 lbs.
598812150OR*	150 ft.	12.75 lbs.



## RescueTECH Rope Cleanser

Reformulated to clean ropes better. Excellent for nylon, polyester, or polypropylene fibers. Excellent cleanser for Harnesses, Slings, and other webbing / fabric products. Concentrated formula can be diluted to suit the dirt or stain encountered. Biodegradable.



599911	1 pint
599910	Concentrate for One Gallon



## Whip-End-Dip

Liquid vinyl compound that seals the end of your rope. Prevents fraying and unravelling. Also, needed information can be marked on an adhesive label then coated with Whip-End-Dip to protect markings. Contents: 4 oz.



599900	White
599904	Red
599909	Clear



## RescueTECH Rope Marking Labels

Self-laminating marking labels. Write or type information on the 1" x 3/4" label and wrap the clear laminating plastic over the white label. Suitable for ropes up to 5/8". The label can then be sealed to the rope with clear Whip-End-Dip. One book contains 60 labels. Weight: 1.2 oz.

5999223	Rope Marking Labels
---------	---------------------

## Rope Washer

Device connects to standard hose for washing or rinsing ropes. Best on light dirt or for rinsing washed ropes.



5999203	Standard (up to 1/2")	6.1 oz.
5999204	Large (up to 3/4")	8.6 oz.

## Dobi Rope Brush

Rope washing the easy way. Just put the rope inside the rope washer, add mild soap and water, and work the Dobi back and forth along the rope. The revolving bristles help to gently remove grime, dirt, and metal oxides from rope. Weight: 3.2 oz.

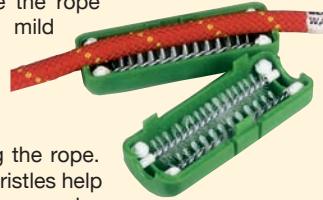

5999211	Dobi Rope Brush
---------	-----------------

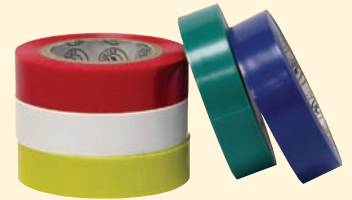

## RescueTECH Equipment I.D. Tape

Used to identify ropes, carabiners, and other equipment. Can be sealed on ropes using Whip-End-Dip or Heat Shrink Tubing. Set includes 5 colors of vinyl tape. Colors: yellow, white, Red, Green, Blue.

599930	Equipment I.D. Tape
--------	---------------------



## Mesh Wash Sack

Great for rope washing, packaging slings, webbing, cords, and personal gear.

805401	Large	15" x 20"
805406	XLarge	24" x 30"

# TECHNote™

## WORKING LOAD LIMIT

Working Load Limit (also known as Safe Working Load or Recommended Working Load) is defined as the maximum load that may routinely be applied to an assembly or component in straight tension. The other strength term is Ultimate Strength (or Tensile Strength). Ultimate Strength is the load at which a component or assembly will fail in a test.

We have chosen to use the NFPA ratio of 15:1 for ropes and the American engineering standard of 10:1 for critical use hardware and auxiliary equipment. We realize that these ratios may exceed proposed standards, but have selected them because they best apply to the rescue community.

We show the Working Load Limit (WLL) because the Ultimate Strength may change during the life of the product. Whereas, the WLL remains valid during the normal life of the product. For example, a 9,000 lbf. rope will lose strength as it is used. The WLL will remain 600 lbs. throughout the normal service life of the rope.

Additionally, rescue products should be chosen and matched based upon their WLL. The item with the lowest WLL limits the system working load limit. Remember, a chain is only as strong as its weakest link.





## RescueTECH Multi-Unit Edge Roller

### Webbing Linkage



Our original M.U.E.R. now links with a length of webbing. Webbing linkage allows the unit to be used to provide large area protection. Units may be linked together. Low Profile design. All units 5.75" wide.



	Units		
611213	Medium	3	208.00
611214	Long	4	278.00

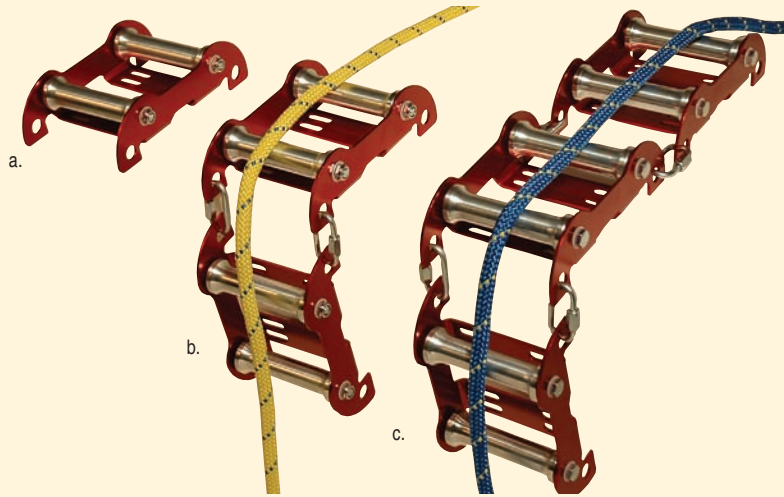

## RescueTECH Multi-Unit Edge Roller

### Rapid Link Connectors



An all-new edge protection device from RescueTECH. Featuring an alloy aluminum frame and rollers, this unit may be used as a single unit or paired-up with other units to provide large area protection using included rapid link. Low Profile design. All units 5.75" wide.

	Units	Length	
a. 611111	XSmall	1	8.25" 90.00
b. 611112	Small	2	17.75" 150.00
c. 611113	Medium	3	26.50" 210.00
611114	Long	4	35.25" 285.00
60510106	Connector Link		2.20



Left: Wide Rope Pad Right: Narrow Rope Pad with Velcro

## RescueTECH Rope Pad

### Super-Heavyweight Cotton Duck

Large 100% cotton rope pads are 2 layers thick in the center and use no synthetic material on its protective surface. Narrow pad with velcro will wrap around rope - secures with hook and loop fastener. Wide pad provides large area coverage. Both pads come complete with rigging grommets for tie-back cords. Color: Natural.

	Dimensions	
612101	Narrow	36 x 12" 21.00
612100	Narrow w/ Velcro	36 x 12" 27.00
612105	Wide	36 x 30" 24.00
612110	Extra Long	36 x 60" 34.00



## RescueTECH Rope Guard

### Super H.D. Cotton Duck Liner

Special protective sleeve made with multiple layers of super heavy cotton canvas. Outside of Rope Guard covered with heavy weight PVC fabric to protect from hazards and to provide distinctive color. Designed to protect ropes from abrasion when stretched across rough surfaces encountered in rappelling, rescue, high rise building maintenance, and other operations. Webbing loops are attached at each end to provide tie-backs to secure rope guard. Specify color: Black, Red.

	Length	
612412X	Small	12" 15.25
612418X	Medium	18" 17.00
612424X	Large	24" 19.00
612436X	XLarge	36" 23.00



## RescueTECH One Piece Edge Roller

### Single Unit Edge / Roof Roller

Fully protects rope from corners and other points of friction. Uses aluminum rollers mounted on Oilite® bushings for extended wear. Alloy aluminum construction, steel fittings. Lightweight and low profile. Four connecting points for easy attachment and linking units together. Works best on 90 degree corners like window ledges or parapet walls. Can also be used as small diameter hose roller. Tensile Strength: 10,000 lbf. Dimensions: 5" x 9". Weight: 30 oz. Color: Gold. Rating: General Use.

611101	One Piece Edge Roller	110.00
--------	-----------------------	--------

Exceeds NFPA 1983/ANSI/OSHA strength specifications.





**NEW**



**Marker™ Search Rope**  
*Complete with 2" Rings  
 and Directional Marking*

7.5mm RescueTECH Egress™ rope complete with 2" rings every 25 ft. Rope is marked with 3/4" nylon balls to indicate distance and direction (3 balls = 75 ft.). Using the phrase "Ring, then Bump = Out to the Pump", a firefighter can identify direction and distance to the exit. Kit includes 200 ft. with Autolocking snap sewn to each end and a Searchline Shoulder bag with quick release seatbelt buckles.

299723200

**Autolocking Aluminum  
 Search Line Snap**

The Autolocking Aluminum Search Line snap was selected by RescueTECH for its Searchline bags because of its ease of use and dependability. Manufactured of forged aluminum, the autolocking gate is easy to open with structural firefighting gloves. Dimensions: 5.5"x 2.75". Strength: 6,700 lbf.

20149014 AutoLock Escape Snap

**Search Line Swivel Snap**

This swivelling connector is the perfect snap to use for connecting the the bitter end of a searchline to the search bag. The gate construction provides an easy to use, straight pull release. Gate opening: 5/8" Dimensions: 2.75" x 1". Non-Load bearing use only.

20465013 Search Line Swivel Snap



**NEW**

Carabiner not Included

**Window Rappel Anchor**

Skedco's unique anchor design allows escape from burning buildings where there are no other anchors available. This is your "Last Chance Bailout" anchor. It will fold to be carried in a holster or bailout kit. When used, the ends are extended, a carabiner is placed into the holes in both parts and the anchor is placed into the lower corner of a window and a rope is attached. It is necessary to keep tension on your rope to prevent the anchor from slipping out of position. This anchor keeps your rope farther away from the flames which gives you a little more time to descend to safety.

Deployed measurements: 10 5/8" x 3" x 5/8". MBS 5,000 lbs. Available in Red or Black. Made in USA.

21177654 Red  
 21177651 Black

DISCLAIMER: Firefighter escape requires instruction and training. Firefighting and associated operations are dangerous and may cause injury or death. It is every firefighters responsibility to be trained and knowledgeable on their equipment and its intended use.



**Escape Hook**  
*Certified to NFPA 1983*

The escape hook is to be used as an anchor in an engineered system for firefighter escape applications or as a component of a system specifically designed by a qualified person for firefighter escape. The user must be trained in the proper usage of the system. The saddle of the hook is designed to easily fit around pipes or framework, and the machined tip is rated for full Working Load Limit. Meets the requirement of NFPA 1983 -Light-Use Auxiliary Equipment. Designed in conjunction with FDNY Research Division. Dimensions: 6.74" x 3.658". Width of Opening: 2.14 in. Weight: .79 lbs.

2416104 Escape Hook

DISCLAIMER: Firefighter escape requires instruction and training. Firefighting and associated operations are dangerous and may cause injury or death. It is every firefighters responsibility to be trained and knowledgeable on their equipment and its intended use.



**ISC RIT Recovery Hook**  
*For Turnout Rescue Loop Attachment*

Strong, yet lightweight, alloy aluminum locking hooks easily attach to NFPA Drag Loops. Webbing and rope slings can be attached to the rigging eye. Locking mechanism is easy to use while wearing structural gloves. Dimensions: 9.5" x 5". Throat Opening: 2.325". Weight: 17 oz. Strength: 8,993 lbf. Gate Side Load Strength: 3,148 lbf. Rating: General Use.

20149994 Recovery Hook

**▲ WARNING**

Technical rescue and safety is potentially hazardous. Any person using equipment sold by RESCUE TECHNOLOGY in any manner is personally responsible for learning the proper techniques involved, and assumes all risks and accepts full and complete responsibility for any and all damages or injury of any kind, including death, which may result from the use of any RESCUE TECHNOLOGY equipment.

**RESCUE TECH**

www.rescuetechn1.com





**RIT Recovery Sling - SNAP**  
*Presewn Recovery Sling*

Sling is actually two heavy duty slings (joined with high strength industrial snaps) that can be separated and used by one, two, or multiple personnel. The snap may be attached to a turnout coat rescue strap, SCBA strap, or back to the second strap. The sling has an included hook & loop strap that compactly holds the folded unit for storage in the included carrying pouch or turnout pocket. Overall Length: 56".

29967230



**Firefighters' RIT Rescue Sling**  
*Easy Deployment / Multi-Use Rescue Tool*

Designed to be a helping hand during fire rescue activities. Easily attached pouch is designed to fit all waist belts and to keep the sling available at all times. Simply grasp the hand loops and pull to deploy this 7 ft. sling. Contoured hand loops are easily grasped by structural firefighting gloves. Multiple uses: RIT, Search, Utility. Can be linked together to help with large area searches. Length: 80".

29967420 Rescue sling



**RIT Recovery Sling - HOOK**  
*A Presewn Recovery Sling*

We designed this product with RIT Team personnel in mind. The sling is actually two heavy duty slings (joined with high strength industrial snaps) that can be separated and used by one, two, or multiple personnel. The hook may be attached to a turnout coat rescue strap, SCBA strap, or back to the second strap. The sling has an included hook & loop strap that compactly holds the folded unit for storage in the included carrying pouch or turnout pocket. Overall Length: 60".

29967220

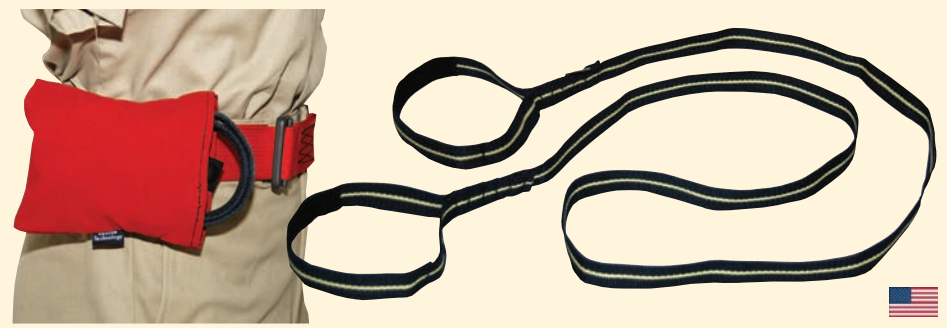

**RIT FR Rescue Sling**  
*Fire Resistant High Strength Sling and Belt Pouch*

Based on the design of our Firefighters' RIT Rescue sling, the FR Sling is manufactured of Fire Resistant Webbing featuring Kevlar® brand fire resistant fibers. Easily attached Fire Resistant pouch is designed fit all waist belts and to keep the sling available at all times. Simply grasp the hand loops and pull to deploy this 7 ft. sling. Contoured hand loops are held open by an internal stiffener and is easily grasped by structural firefighting gloves. Multiple uses: RIT, Search, Utility. Can be linked together to help with large area searches.

29967521 FR Rescue sling

**Firefighters Drag / Search Sling**  
*Handles with Rubberized Grips*

Designed to aid Firefighters and RIT Team personnel. Stored in an included pouch that will attach to SCBA waist straps or will store in Turnout Gear pockets. The sling is comprised of heavy duty 1" tubular webbing, forged steel D-Ring, non-locking aluminum carabiners, and custom handles with rubberized grips and reflective tape. Overall Length of Red Rescue Sling: 70".



Stows in Included Pouch

2369104



### Corona™ Fire Resistant Truck / Escape Belt

Made to meet NFPA Class I Ladder / Escape Belt standards. Belt is easily secured around waist using unique double locking snap hook and 'D' Ring adjuster. Can be used as an equipment belt for carrying axes or forcible entry tools. Two light weight D-rings slide along belt to secure escape rope system. Retro-reflective striping. Strength: 6,000 lbs. Weight: 12 oz. Fits Waist size 34" - 56".

701132 Fire Resistant w/ Scotchlite®

*Meets structural test requirements of Life Safety Escape Belt Standard. Meets ANSI/OSHA Class I Belt design requirements.*



### Corona™ Truck / Escape Belt

Made to meet NFPA Class I Ladder / Escape Belt standards, this Nylon Escape Belt is the perfect economical substitution for our Kevlar Belt. Belt is easily secured around waist using unique double locking snap hook and 'D' Ring adjuster. Can be used as an equipment belt for carrying axes or forcible entry tools. Two light weight D-rings slide along belt to secure escape rope system. Retro-reflective striping on Gold unit. Strength: 6,000 lbs. Weight: 12 oz. Fits Waist size 34" - 56".

701032 Gold w/ Scotchlite®  
701031 Black 70.00

*Meets structural test requirements of Life Safety Escape Belt Standard. Meets ANSI/OSHA Class I Belt design requirements.*



### Turnout Escape Harness

Designed to be kept with your turnout gear, this harness may be worn on the outside or between the barrier layer and shell layer. Special Klik Lok buckle and attachment strap allows this harness to be easily donned. Waist buckle requires both triggers to be depressed before disengagement. Extended "D" ring rigging pointeases attachment. Standard fits waist size 28" - 44". XL fits waist size: 38" - 54". Sizing should be determined by waist measurement while wearing turnout pants.

7021131 Nylon, Std  
7021151 Nylon, XLarge  
7021231 Fire Resistant, Std  
7021251 Fire Resistant, XLarge

### Fire Resistant Truck Lanyard

For use in high abrasion and high heat conditions. Ideal for use on Ladder and Platform trucks. The exceptional heat resistance of Dupont Brand Kevlar® will help those in high heat jobs such as welding, brazing, foundry, etc. Length: 6 ft.

753786F Kevlar® Lanyard w/ Zorber and Ladder Hook



### Corona™ Truck / Escape Belt with Ladder Hook

Our popular Fire Resistant Corona Escape Belt with integral Ladder Hook. Manufactured of Kevlar® Brand fibers from Dupont and forged hardware. Retro-reflective striping. One-Size-Fits Most. Ladder Hook manufactured from high strength, alloy aluminum. Perfect for use in ladders and platforms. Belt Strength: 6,000 lbs. Hook Strength: 5,000 lbs.

701132H Fire Resistant w/ Ladder Hook

*Meets structural test requirements of Life Safety Escape Belt Standard. Meets ANSI/OSHA Class I Belt design requirements.*





### Survival Belt™ II

A multi-purpose belt for emergency rappels, belays, restraint straps, anchor slings, tourniquets, etc., that can be worn as a uniform belt. With carabiner attached to the forged buckle, the belt allows the user to "get out quick". New design uses high strength Adjustable Rigging Buckle. Hook and Loop neatly secures spare length. Manufactured with 1 3/4" heavy duty webbing. Tensile Strength: 6,000 lbf. Color: Black. Weight: 8 oz.

		Waist
703521	Small	25" - 36"
703531	Medium	32" - 42"
703541	Large	36" - 48"
703551	XLarge	40" - 55"

*Meets NFPA 1983 requirements for Class I Harness.  
Meets ANSI/OSHA Class I Belt design requirements. NFPA Rating: Escape belt.*



### Ladderman's Class II Harness

**Fire Resistant, Convertible Belt / Harness**

A new concept in Ladder Harnesses. Fire resistant Kevlar® webbing provides extra security in high temperature and abrasive environments. Double locking, quick-attach snap at waist allows harness to be easily donned while in turnout gear. Leg straps are conveniently stowed in Nomex pouches until needed and can be donned by simply connecting quick attach snaps. When combined with our Rigger Ladder Hook Extension, the Ladderman's Harness is the perfect combination for safety on ladders and towers. Includes mesh storage bag. Proof Load: 5,000 lbs. Design Load: 600 lbs. Weight: 40 oz.

701230	Ladderman's Harness
--------	---------------------

*Meets structural test requirements of Life Safety Harness Standard. Meets ANSI/OSHA requirements.*



### Uniform Emergency Belt

**Quick Adjust Buckle**

A modified version of our Survival Belt™. Lightweight forged "V" ring is used for carabiner attachment point and is held securely by a velcro loop. Forged Steel Adjuster Buckle insures security without slipping. Extra webbing secured with hook and loop fastener. Tensile Strength: 5,000 lbf. Color: Black or Red. Weight: 8 oz.

	BLACK	Waist
703306	Standard	28" - 40"
703308	Large	40" - 55"

*Meets NFPA 1983 requirements for Class I Harness.  
Meets ANSI/OSHA Class I Belt design requirements. NFPA Rating: Escape Belt.*



	RED	Waist
7033164	Standard	28" - 40"
7033184	Large	40" - 55"

### Fire-Resistant Truck / Escape Belt

Unique fire resistant "belt" to meet NFPA Class I Ladder / Escape Belt standards. Belt is easily secured around waist using unique double locking snap hook and 'D' Ring adjuster. Can be used as an equipment belt for carrying axes or forcible entry tools. Two light weight D-rings slide along belt to secure escape rope system. Color: Black. Weight: 12 oz. Standard fits waist size 34" - 56". XL fits waist size: 44" - 68".

701131	Standard
701131XL	XLarge

*Meets structural test requirements of Life Safety Escape Belt Standard.  
Meets ANSI/OSHA Class I Belt design requirements.*



### Truckman's Tool Holster

**Fits Most Harnesses**

New design tool / axe holster for rescue harnesses. Fits onto any webbing up to 1.75 inches with heavy duty hook and loop fastener system. Adjustable webbing strap holds tool in place. Fits axes, Halligan tool, etc.

609150	Tool Holster
--------	--------------



## ▲ WARNING

Technical rescue and safety is potentially hazardous. Any person using equipment sold by RESCUE TECHNOLOGY in any manner is personally responsible for learning the proper techniques involved, and assumes all risks and accepts full and complete responsibility for any and all damages or injury of any kind, including death, which may result from the use of any RESCUE TECHNOLOGY equipment.

## RescueTECH VANGUARD™ Rescue Technician Harness

A new harness for Rope Rescue Technicians. TUV Certified to NFPA 1983. Designed for function and comfort. Easy donning aided by 2-piece color coded leg and waist buckles. Special breathable padding keeps rescuers comfortable during exertion. Forged D rings at the front waist and chest provide rescuer main and belay attachments. Forged dorsal 'D' ring for fall protection and belay attachments. Lifting rings on shoulders allow vertical lifting with the RescueTECH Heavy Rescue Lifting Bridle. Canted side 'D' rings provide attachment point for positioning lanyards. Over the shoulder donning of the chest/shoulder section. Shoulder section attached to seat section with Delta Link.

711202	Small
711302	Medium/Large
711502	XLarge

Size	Height	Waist
S	5'2"-6'	27-35"
M/L	5'2"-6'	31-39"
XL	5'9"-6'8"	35-51"

Meets NFPA, OSHA, ANSI and CE requirements.



## OBSERVER NFPA Class III Rope Access Harness

Our newest rope access harness. TUV Certified to NFPA 1983. We have partnered with premier harness manufacturer Singing Rock to supply Rope Access Technicians with a Lightweight, yet durable, multi-use harness. 2-piece leg buckles facilitate donning of this harness. Rigging rings at the front waist and chest as well as a dorsal D ring fulfills the main attachment point requirements for rope access. Side positioning D rings allow lanyards to be used to hold the user to the structure. Lightweight, breathable padding on the waist, legs, and shoulders make this harness's comfort unsurpassed.

23890803	Medium/Large
23890804	XLarge

Meets NFPA, OSHA, ANSI and CE requirements.

Size	Height	Waist
M/L	5'2"-6'	31-39"
XL	5'9"-6'8"	35-51"



## OBSERVER-T™ Rope Access Tower Harness Includes Chest Ascender

An updated version of our Observer Harness that includes a chest ascender for vertical rope access use.

239818031	Med/Large
238918041	XLarge

Certified to NFPA 1983/2001 ed. standards.  
Meets ANSI/OSHA full body harness standards

Size	Height	Waist
M/L	5'2"-6'	31-39"
XL	5'9"-6'8"	35-51"



## TECHNote™ Quick Attach Leg Buckles



Many RescueTECH harnesses come with Quick-Attach Adjuster Buckles. These buckles allow the user to don a harness without stepping through a leg loop. With the Quick-Attach buckles, the user simply wraps the loop around their leg, attaches the buckles together, and tightens the webbing. These buckles provide an easy way to put a harness onto a victim.





## Voyager Rescue Harness

Light weight design provides ease of use. Features quick adjust legs and waist. 5" waist pad for extra comfort. Chest harness attaches to waist with a high strength stainless steel rapid link for corrosion resistance. Quick-adjust leg buckles.

718326	Small
718336	Medium
718346	Large
718356	XLarge

UL Certified to NFPA 1983 Class III Harness. Meets ANSI/OSHA Class III Full Body Harness requirements.

Size	Height	Waist
SM	5'4" - 6'0"	28" - 33"
STD	5'5" - 6'4"	32" - 36"
LG	5'5" - 6'4"	35" - 39"
XL	5'5" - 7'0"	39" - 50"



## Technical Rescue Harness

Attachment points on chest, waist (front and back), back, and shoulders make this one of the most versatile harness for rescue. Made of highest quality nylon webbing and custom designed 5" waist comfort pads. Waist utilizes special double locking quick connect snap and Locking V ring adjuster for a side-entry design. Leg section utilizes color coded quick-connect two piece buckles. Color: Blue w/ Black pads. Weight: 94 oz.

716126	Small
716136	Medium
716146	Large
716156	XLarge

UL Certified to NFPA 1983 Class III Harness. Meets ANSI/OSHA Class III Full Body Harness requirements.

Size	Height	Waist
SM	5'5" - 5'9"	26" - 31"
MD	5'5" - 6'4"	30" - 36"
LG	5'5" - 6'4"	35" - 40"
XL	5'5" - 7'0"	38" - 48"



## Heavy Rescue Harness Combines Fall Protection and Rescue

The Heavy Rescue Harness has four "D" rings - one on the seat harness, one on each shoulder and one "Dorsal 'D' Ring" in the back positioned between the shoulder blades allowing a near vertical lift when wearing an air pack. Special two-piece quick connect leg buckles aid in donning the Heavy Rescue Harness. Waist connects with fast-connect 2 piece safety buckle. Includes padded shoulder straps and mesh storage bag. Weight: 80 oz.

705310	XSmall
705330	Standard
705350	XLarge

UL Certified to NFPA 1983 Class III Harness. Meets ANSI/OSHA Class III Full Body Harness requirements.

Size	Height	Waist
XS	5'5" - 5'9"	24" - 36"
STD	5'5" - 6'4"	26" - 54"
XL	5'5" - 7'0"	34" - 64"



## RescueTECH™ Lifting Bridle Double Locking Snaps

Unit attaches to shoulder lifting rings with industrial double locking snaps. Overall Height: 23". Strap Length: 11" Width: 16". Weight: 32 oz. Strength: 6,000 lbf.

609025

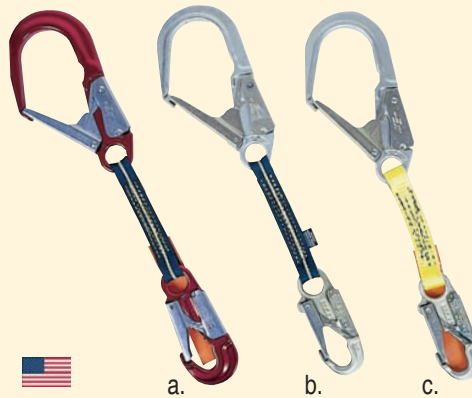

## Ladder Hook Extension™

The Ladder Hook Extension Strap allows the rescuer to attach to a ladder rung. The overall length of 18" provides the perfect length to give the rescuer both comfort and safety. Available with Autolocking Ladder Hook. Forged snap attaches the Ladder Hook Extension to the "D" ring of rescue harnesses. Weight: Steel: 34 oz.; Aluminum: 24 oz. Overall Length: 18". Strength: 6,000 lbs.

a. 609012	Alum. AutoLock - Fire Resist.
b. 609011	Steel AutoLock - Fire Resist.
c. 609001	Steel AutoLock - Nylon



## Wristlet Ergonomic Comfort Pads

Wrist harness for emergency use and for work locations where a full body harness might create a greater risk. Also excellent for situations requiring special positioning of the victim's arms in conjunction with a full body harness. Manufactured from nylon webbing. Special elastic tensioner helps keep unit secure when used as anklet. Comes complete with 2 wristlets and lifting yoke. Weight: 10.5 oz.

609200 Wristlet

Meets OSHA requirements.





## NAVAHO® BOD

### Multi-purpose harness

Excellent balance between comfort when hanging and freedom of movement. Sternal and dorsal attachment points can be used to connect a fall-arrest system and help ensure that the user is suspended in the correct position after a fall. One ventral and two lateral attachment points for multiple hands-free work positioning configurations. Leg loops equipped with DoubleBack or FAST buckles.

235471001	Navaho, S/M
235471002	Navaho, L/XL
235471011	Navaho Fast, S/M
235471012	Navaho Fast, L/XL

UL Certified to NFPA 1983 Class III Harness. Meets ANSI/OSHA Class III Full Body Harness requirements.

Size	Height	Waist
STD	5'3" - 5'11"	28" - 47"
XL	5'8" - 6'6"	32" - 55"



## Voyager Riggers

Low-visibility version of popular Voyager Rescue without shoulder D rings. Features quick adjust legs and waist. 5" waist pad for extra comfort. Chest harness attaches to waist with a high strength stainless steel rapid link for corrosion resistance. Specify Size.

718321	Small, Black
718331	Medium, Black
718341	Large, Black
718351	XLarge, Black

UL Certified to NFPA 1983 Class III Harness. Meets ANSI/OSHA Class III Full Body Harness requirements.

Size	Height	Waist
SM	5'4" - 6'0"	28" - 33"
STD	5'5" - 6'4"	32" - 36"
LG	5'5" - 6'4"	35" - 39"
XL	5'5" - 7'0"	39" - 50"



## OBSERVER-R™ Riggers Full Body Harness

### Certified to NFPA 1983

The Observer-R is designed padded waist belt and leg-loops for superior comfort. Quick-adjust buckles on waist belt, leg-loops and shoulder straps ease donning and doffing the harness. Descender attachment point, rear fall arrest attachment point, and positioning belt with two attachment elements conforms with international requirements\*. Two gear loops

238908031	Medium/Large
238908041	XLarge

\* Descender EN813, Rear Fall Arrest EN361, Side positioning Rings EN368.

Size	Height	Waist
M/L	5'2"-6'	31"-39"
XL	5'9"-6'8"	35"-51"



## RTR Harness

Designed to meet the demands of the transmission line worker, structural access and the rope access professionals. Chest harness designed to incorporate a chest ascender (not included). Attachment points at waist, hips (positioning), chest (positioning), back (lumbar) and back (fall arrest). Extra large, side positioning rings (lineman style). Weight 6 lb. 11 oz.

204239012	Small
204239013	Medium
204239014	Large
204239015	XLarge

Certified to NFPA 1983 standard. Certified to ANSI/OSHA and CAN/CSA full body harness standards



## Rigger's Full Body Harness

Adjuster buckles on both sides of the harness keep the waist pad and "D" rings centered on the user. Great for instructors. Special Loop at chest for ladder climbing and self-rescue. Side positioning rings let user lean back in comfort. 5" padded waist and 3" padded legs. Includes mesh storage bag. Color: Black. Weight: 106 oz.

712201	Small
712301	Medium
712401	Large
712501	XLarge

Meets ANSI/OSHA Class III Full Body Harness construction requirements.

Size	Height	Waist
SM	5'4" - 6'0"	28" - 33"
STD	5'5" - 6'4"	32" - 36"
LG	5'5" - 6'4"	35" - 39"
XL	5'5" - 7'0"	39" - 50"



## Basic Rope Access Harness

A tuned down version of the Professional Tower Rope Access harness. Waist belt portion of the harness uses smaller sized D-rings to save weight and reduce bulk. New StabLock quick release adjustable buckles on legs. Attachment points at waist, hips (positioning), chest (positioning), back (lumbar) and back (fall arrest). Chest harness designed to incorporate a chest ascender (not included) for rope access work. Weight 5 lb. 6oz.

204238712	Small
204238713	Medium
204238714	Large
204238715	XLarge

Certified to NFPA 1983 standards. Certified to ANSI/OSHA and CAN/CSA full body harness standards



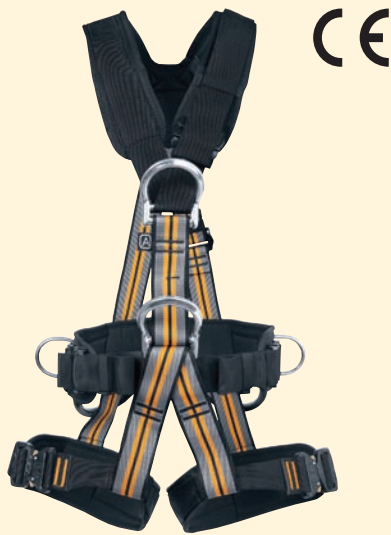

**OPERATOR**  
Work / Access Harness

Fast-Connect Cobra buckles allow easy and quick manipulation when putting the harness on. Anatomically shaped waist and leg pads provide comfort when hanging in the harness. Lightweight, excellent functionality, quick and easy adjustment makes your work safe and efficient. Size: S, M/L, XL CE 0123 • EN 358 • EN 361 • EN 813

2389052220	Small
2389052230	Medium/Large
2389052250	XLarge

Size	Height	Waist
M/L	5'2"-6"	31-39"
XL	5'9"-6'8"	35-51"



**Rigger's BODY™**  
Fall Protection Harness

Fully adjustable fall arrest harness with two attachment points in conformity with ANSI and EN 361. Works well as a victim rescue harness. CE certified.

238903421	Small
238903431	Medium/Large
238903451	XLarge

Meets all ANSI, OSHA standards and CSA construction requirements for Class III Harness.



**BODY™**  
Fall Protection Harness

Fully adjustable fall arrest harness with two attachment points in conformity with ANSI and EN 361. Works well as a victim rescue harness. CE certified.

238903220	Small
238903230	Medium/Large
238903250	XLarge

Meets all ANSI, OSHA standards and CSA construction requirements for Class III Harness.



**Rope Dancer™**  
Fall Protection Harness

Easy to don and easy to operate double buckles. Front and rear belay/rappel front attachment points. Reinforced tie-in loop. Full body harness designed specially for rope course.

23890502	Small
23890503	Medium/Large
23890505	XLarge

Meets all ANSI, OSHA standards and CSA construction requirements for Class III Harness.



1 "D" Fall Protection Harness      1 "D" with Positioning Rings

**Industrial 1 'D'**  
Full Body Harness  
"D" Ring Between the Shoulders

Manufactured from color coded 1 3/4" polyester webbing for ease of donning. Forged steel hardware with quick-connect friction buckles for quick secure adjustments. One sliding "D" between the shoulder blades in back for attachment of lanyards, etc. Sized to fit over clothing. Positioning version has two rings at waist level. Weight: 32 oz.

702132	Small/Large
702142	Large/XLarge

702132P	Positioning Rings, Small/Large
702142P	Positioning Rings, Large/XLarge

Meets all ANSI, OSHA standards and CSA construction requirements for Class III Harness.



3 "D" Fall Protection Harness      3 "D" with Positioning Rings

**Industrial 3 'D'**  
Full Body Harness  
"D" Rings for Lifting / Fall Protection

Manufactured from color coded 1 3/4" polyester webbing for ease of donning. Forged steel hardware with quick-connect friction buckles for quick secure adjustments. One sliding "D" between the shoulder blades in back for attachment of lanyard and two shoulder lifting rings. Sized to fit over clothing. Positioning version has two rings at waist level. Weight: 38 oz.

702332	Small/Large
702342	Large/XLarge

702332P	Positioning, Small/Large
702342P	Positioning, Large/XLarge

Meets all ANSI, OSHA standards and CSA construction requirements for Class III Harness.





CE

### Worker™ Padded Seat Harness

Our newest Class II seat harness will impress you with its versatility and comfort. Special “breathable” laminated foam padding provides comfort not often found in basic seat harnesses. Special locking buckles allow you to don without having to “step-through” the harness. Primary rigging “D” ring floats along the waist strap to better balance the forces placed on the rescue - giving greater comfort. Side “D” rings allow for placement of positioning slings.

2389133 Medium/Large  
2389135 XLarge

Exceeds ASTM/ANSI/OSHA requirements for Seat Harness.



UL

### NFPA Padded Seat Harness 5” Waist Pad with Gear Loops

Same construction and specification as the NFPA Harness (right) but with special “floating” pads on the waist and legs. 4” waist pad slides to allow adjustment for multiple sizes. Gear loops on waist pad for attachment of additional equipment. 3” leg pads for superior comfort. 5” waist pad is made from custom-designed laminated foam. Exterior of pad is tough Cordura Nylon. Interior of pad is a special wicking material to pull sweat away from the rescuer’s body. Includes mesh storage bag. Weight: 48 oz.

		Waist	Gear Loops
714201	Small	25” - 32”	2
714301	Medium	30” - 50”	4
714401	Large	36” - 54”	4

UL Certified to NFPA 1983 Class II Harness. Meets ANSI/OSHA requirements.



UL

### NFPA Seat Harness Comfortable / Non-Padded

Heavy duty 2” waist (Strength: 6,000 lbf.) is completely adjustable for all waist sizes 25 through 50 inches. Quick-adjust waist buckle for security and quick-adjust over-width leg loops provide comfort and adjustability. Forged “D” ring attachment point has a proof load of 5,000 lbf. and has been tested to 8,000 lbf. Equipment loops for carrying additional gear. Contrasting stitching for visual inspection of thread wear. Gear loop provides convenient place to hang tools. Includes mesh storage bag. Tensile Strength: 6,000 lbf. Weight: 32 oz.

704401 Fits Waist 25” - 50”

UL Certified to NFPA 1983 Class II Harness. Meets ANSI/OSHA requirements.



CE

### Worker™ Chest Harness

Fully adjustable chest harness. When used in combination with the Worker Padded Seat Harness, the Worker Chest harness creates a fully adjustable full body harness in conformity with EN 361 - Great for Work Access Use. Quick-Adjust buckles on shoulder straps. Do not use separately! Carabiner not included.

23891213 Worker Chest Harness



CE

### TIMBER™ Full Function Seat Harness

Adjustable sliding D-ring enables you to take safe, comfortable and effective work position. Wide padding provides superior comfort. Side D-rings for work positioning or gear attachment. 4 gear loops

238900123 Med/Large  
238900125 XLarge



CE

### Franklin Work Positioning Seat

The Franklin Work Positioning Seat provides more comfort when hanging in the harness and is intended for use with our fall arrest or work positioning harnesses. Easy to adjust buckles. Wide sitting area gives good stability and comfortable hanging as well as standing work position. Suspension straps do not press on your thighs. Three D-rings (bearing capacity 110 lbs.) for gear. Max. load of seat: 500 lbs. Weight: 3.6 lbs.

23898110 Franklin

WARNING:  
Shoulder straps are not for vertical lifting!

RESCUE TECH

www.rescuetechn1.com





## Adjustable Seat Harness

A medium duty version of the NFPA Harness. Manufactured of sturdy 2" webbing and forged hardware. Double pass waist buckle provides non-slipping adjustment. Quick-adjust leg loops allow the rescuer to don this harness with ease. Forged "D" ring provides a secure attachment point for carabiners. Equipment loops for attaching extra hardware. Used in all types of rappelling and rescue situations. 2 gear loops. Weight: 27 oz. Color: Black.

		Waist
710231	Medium	28 - 33"
710241	Large	34 - 40"
710251	Extra-Large	40 - 46"

Exceeds ASTM/ANSI/OSHA requirements for Seat Harness.



## Ladder / Victim Harness Quick-Connect Buckles

An innovative dual purpose harness, built to NFPA standards. Constructed of 1 3/4" high strength webbing, the Ladder/Victim Harness utilizes special forged color-coded quick-connect friction buckles on legs to aid in proper donning. Leg straps are stored in attached pouch to easily store and transport this harness. Special waist buckle pad insures user comfort. Color: Orange w/ contrasting leg straps. Weight: 32 oz.

708360 Ladder / Victim Harness  
Exceeds NFPA 1983 requirements for Class II Harness.



## Victim Chest Sling

Attaches to Ladder / Victim Harness, turning the system into a Class III Victim Harness. Wide, padded chest strap supports victim's upper torso during vertical lifts. Quickly attaches around victims chest. Connects with Double Locking Snap. Padded for comfort. Adjustable Chest and seat connector straps.

723201 Victim Chest Sling



## Adjustable TAC Harness Soft Connect Tactical Version

The TAC Harness is a version of our Adjustable Seat Harness with a modified rigging point. Many tactical teams requested a soft-connect version to reduce the metal-on-metal noise produced when a carabiner is attached to a 'D' ring. Quick-adjust leg loops allow the rescuer to don this harness with ease. Forged "D" ring provides a secure attachment point for carabiners. Equipment loops for attaching extra hardware. Used in all types of rappelling and rescue situations. 2 gear loops.

		Waist
710331	Medium	28 - 33"
710341	Large	34 - 40"
710351	Extra-Large	40 - 46"



## Standard Chest Harness General Purpose Chest Harness

A basic style chest harness with "V" ring attachment points that can be connected with a carabiner or rope. The Standard Chest Harness features 2" chest strap webbing and 2" shoulder strap webbing. Fully adjustable. One Size Fits Most. Color: Black. Weight: 12.5 oz.

723321 Standard Chest Harness  
Exceeds NFPA construction requirements.  
Meets ANSI Class II Harness construction requirements.

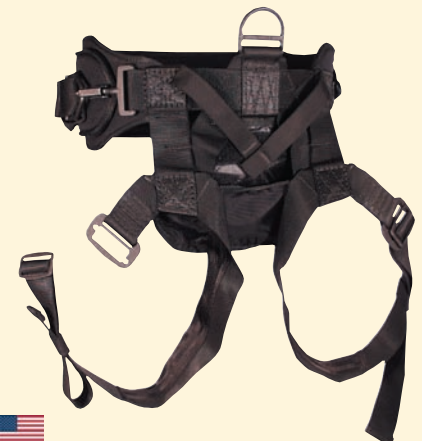

## Tactical Rappel Harness w/ 'D' Ring Quick Fit Waist Buckle

The Tactical Rappel Harness w/ "D" Ring is a unique configuration intended for Tactical Operations. Can be worn as a belt then converted to a seat harness by simply pulling the leg portion from the waist pouch. Auto-Locking snap secures waist and forged 2-piece friction buckles secure leg loops. Optional 4" waist pad designed to accept ALICE clips. Color: Black

727321 Tactical Harness w/ D Ring  
Meets NFPA/ASTM/ANSI/OSHA requirements for Seat Harness.

**WARNING:**  
Shoulder straps are not for vertical lifting!





- Forged Steel attachment points
- Heavy Duty Webbing
- Rolls up for Storage
- Contoured Grab Handles aid Rescuers
- Padded Back Panel with internal polycarbonate support frame



### Deluxe Victim Rescue Cradle

Full Upper Body coverage with padded back panel for greater patient comfort and security. 7 strap support for superior strength. Forged D Tag line anchor helps rescuers control patient in vertical environment. Victim Arm Keepers maintain control of upper extremities. 4 Grab handles aid in maneuvering victim before, during, and after the vertical lift. Manufactured of 1000 den fabric with Cordura brand fibers, high strength webbing and forged steel hardware. (Manikin, Carabiner, and Tether not included.)

708353 Rescue Cradle\*

*\*Does not replace proper patient packaging using backboard, cervical collar, and head blocks.*



### Mesh Evacuation Triangle Features Adjustable Center Strap

Full body support for security and comfort. Easily installed on seated or standing persons. Grid design of webbing fully supports patient while mesh provides extra comfort as well as drainage for use in water rescues. Includes adjustable shoulder straps. Constructed of heavy duty Vinyl coated polyester mesh high strength webbing. Forged 'D' ring rigging points. High visibility contrast stripe for day or night use. Weight: 46 oz.

708352 Mesh Evacuation Triangle\*



### Laika Dog Harness

Intended for transport of the dog from a helicopter or other high angle environments. Universal size. Aluminum-alloy adjusters. Color: Orange. Capacity: 300 lbs.

23898115 Laika

### Axillar Rescue Sling For Ski Lift / Tower Rescue

The Axillar Rescue Sling is used to secure persons to be evacuated from ski lifts while the rescuers prepare the rescue equipment. Simply deploy sling, attach to an anchor point, and attach to victim. Multiple units secures victims in chair lifts awaiting rescue using the Evacuation Triangle. Meets EN1498, Type A.



23898109 Axillar Rescue Sling

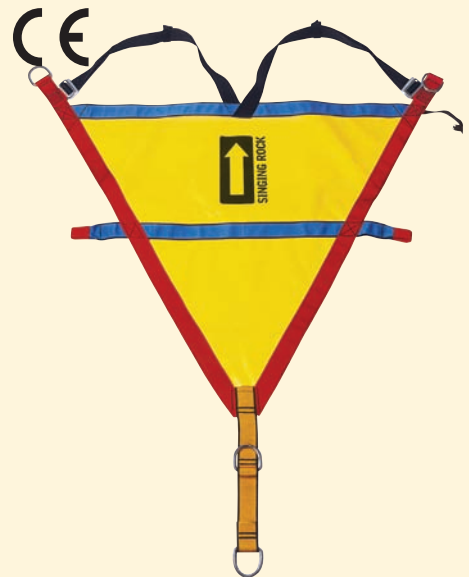

### Evacuation Triangle with Shoulder Straps

A new design from our friends at Singing Rock. Complete with Shoulder Straps, this triangle offers multiple uses for victim evacuation. Versatile construction. Weight: 27 oz.

23898213 Evac Triangle w/ Straps\*



GENERAL USE



## RD70™ Rescue Carabiner

Rescue Tech's newest general use carabiner. Design to meet the tough-use conditions met by Rescue Technicians. Heat-treated alloy steel construction with Gold Chromate corrosion protection.

Strength	15,737 lbf.	70 kN
WLL	1574 lbs.	715 kg
Gate Opening	1.4"	35 mm
Dimensions	5.9 x 3.6	150 x 90 mm
Weight	12.5 oz.	360gm
NFPA Rating:	General Use	

- 60511820 Screwgate, Gold
- 60511821 Screwgate, Black

GENERAL USE



## OD50™ Rescue Carabiner A Great Multi-Use Carabiner

Heat-treated alloy steel construction with Gold Chromate corrosion protection. Made to meet the toughest rescue needs.

- 60511750 Screwgate, Gold
- 60511751 Screwgate, Black

- 60511730 Twistlock, Gold
- 60511731 Twistlock, Black

- 60511760 Screwgate w/ bar
- 60511740 Twistlock w/ bar

Strength	11,241 lbf.	50 kN
WLL	1124 lbs.	511 kg
Gate Opening	.8"	20 mm
Dimensions	4.25 X 2.5"	112 x 64mm
Weight	7.7 oz.	220 gm
NFPA Rating:	General Use	



GENERAL USE

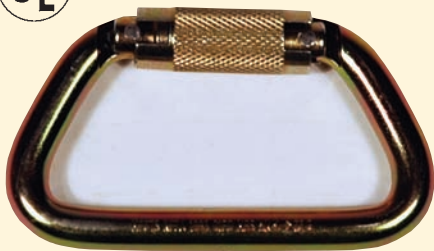

## RescueTECH™ Large D Supersafe

### 3-Stage Autolock Rescue Carabiner

The newest version of our popular Large D Rescue Carabiner. Featuring the triple-locking Supersafe gate design.

Strength	16,187 lbf.	72 kN
WLL	1,618 lbs.	735 kg
Gate Opening	1.02"	25.5mm
Dimensions	4.96 x 2.8"	126 x 71mm
Weight	10.3 oz.	293 gm

- 6050184 Large D, Supersafe

UL Certified NFPA 1983.  
Meets ANSI/OSHA strength requirements.

GENERAL USE



## RescueTECH™ Wide Gate 'D'

### Extra-Wide Gate Opening

Classic design with an extra-large gate opening. NFPA Rating: General Use.

Strength	16,187 lbf.	72 kN
WLL	1,618 lbs.	735 kg
Gate Opening	1.4"	36 mm
Dimensions	4.96 x 2.79	126 x 71 mm
Weight	10.2 oz.	289 gm

- 6050185 Wide Gate 'D' Steel

UL Certified NFPA 1983.  
Meets ANSI/OSHA strength requirements.



GENERAL USE



## RescueTECH Big Dan

### Designed to Prevent Cross-Loading

Combines all the ideal design ideas into one carabiner. The Big Dan's unique frame is design to prevent cross-loading the carabiner. Cross-loads are quickly realigned to the major axis. The curved back modified 'D' design optimizes the strength and handling characteristics. Available in Twistlock, Supersafe (3 stage) and Quadlock (4-Stage) safety mechanisms.

Strength	11,241 lbf.	50 kN
WLL	1,124 lbs.	511 kg
Gate Opening	1.0"	25 mm
Dimensions	4.8 x 3.5"	123x90 mm
Weight	9.8 oz.	278 gm

- 6051179Q Quadlock - 4 Stage
- 6051179S Supersafe - 3 Stage
- 6051179T Twistlock - 2 Stage

Meets NFPA 1983/ANSI/OSHA strength requirements.



## RescueTECH™ Extra-Large Rescue 'D' Extra Large 1.5" Gate Opening

A new design in rescue carabiners. Extra-large gate and interior dimensions let this carabiner's gate close over any round structure that will fit through the gate. 1/2" alloy steel plated with Gold Chromate. Gate locking design.

Strength	12,589 lbf.	56 kN
WLL	1,259 lbs.	572 kg
Gate Opening	1.5"	38 mm
Dimensions	5.98 x 3.66"	152 x 93 mm
Weight	12.8 oz.	363 gm

6050159 XL Rescue D



GENERAL USE

UL Certified NFPA 1983.  
Meets ANSI/OSHA strength requirements.



GENERAL USE



## RescueTECH™ Large 'D' Screwgate The Basic Tool of Rescue

Traditional design facilitates use in all rescue systems. Gold or Black Chromate plating over 1/2" alloy steel distinguishes this American-made carabiner. Gate locking design prevents locking collar from jamming as a result of being tightened after load is applied.

Strength	16,187 lbf.	72 kN
WLL	1,618 lbs.	735 kg
Gate Opening	1.02"	25.5mm
Dimensions	4.96 x 2.8"	126 x 71mm
Weight	10.3 oz.	293 gm

6050182 Gold  
6050183 Black

UL Certified NFPA 1983.  
Meets ANSI/OSHA strength requirements.

GENERAL  
USE



GENERAL  
USE



## RescueTECH™ Offset 'D' High Strength / Lightweight

The best of American-made carabiners. High strength, heat treated 7/16" diameter alloy steel, and large gate opening, make this the ideal carabiner for rescue. Plated with gold or black chromate to increase resistance to corrosion. Gate locking design of the locking collar helps prevent accidental over-locking of gate after load is applied. Screwgate with internal threads to eliminate rope wear. Each carabiner is marked with strength and manufacturing batch number.

Strength	11,915 lbf.	53 kN
WLL	1,192 lbs.	542 kg
Gate Opening	.944"	24 mm
Dimensions	4.37 x 2.75"	111x70 mm
Weight	7.4 oz.	210 gm

6050170 Offset 'D' Locking (Gold)  
6050171 Offset 'D' Locking (Black)

Meets NFPA 1983/ANSI/OSHA strength requirements.

## RescueTECH™ Offset 'D' Autolocking

The first U.S. made autolocking carabiner. Using the traditional 7/16" Offset Carabiner Frame, the Autolock utilizes a locking collar with a unique autolocking design. Plated with gold or black chromate to increase resistance to corrosion. Each carabiner is marked with manufacturers part number, strength, and manufacturing batch number.

Strength	11,915 lbf.	53 kN
WLL	1,192 lbs.	542 kg
Gate Opening	.944"	24 mm
Dimensions	4.37 x 2.75"	111 x 70mm
Weight	7.4 oz.	220 gm

6050173 Autolock (Gold)  
6050174 Autolock (Black)  
6050176 Autolock, Captive Eye  
6050177 3-Stage Autolock

Meets NFPA 1983/ANSI/OSHA strength requirements.



LIGHT  
USE

## Stainless Steel Offset 'D' Proof Tested

Stainless Steel provides excellent corrosion resistance. Rating: Light Use.

Strength	7,870 lbf.	35 kN
WLL	787 lbs.	358 kg
Dimensions	4.5" x 2.5"	118 x 64mm
Gate Opening	.8"	20mm
Weight	7.9 oz.	225 g

6053120 Twistlock  
6053121 Supersafe

Meets NFPA/ANSI/OSHA strength requirements.

## ▲ WARNING

Technical rescue and safety is potentially hazardous. Any person using equipment sold by RESCUE TECHNOLOGY in any manner is personally responsible for learning the proper techniques involved, and assumes all risks and accepts full and complete responsibility for any and all damages or injury of any kind, including death, which may result from the use of any RESCUE TECHNOLOGY equipment.

RESCUE TECH

www.rescuetechn1.com





**Iron Wizard Ladder Hook**  
*Mid-Sized Rescue Ladder Hook*

New Ladder Hook for use where space is limited. Ideal for use in confined spaces to reduce overhead length of rigging systems. Dimensions: 6.8" x 3.8" Strength: 70 KN. Rating: NFPA General Use.

6051186 Iron Wizard

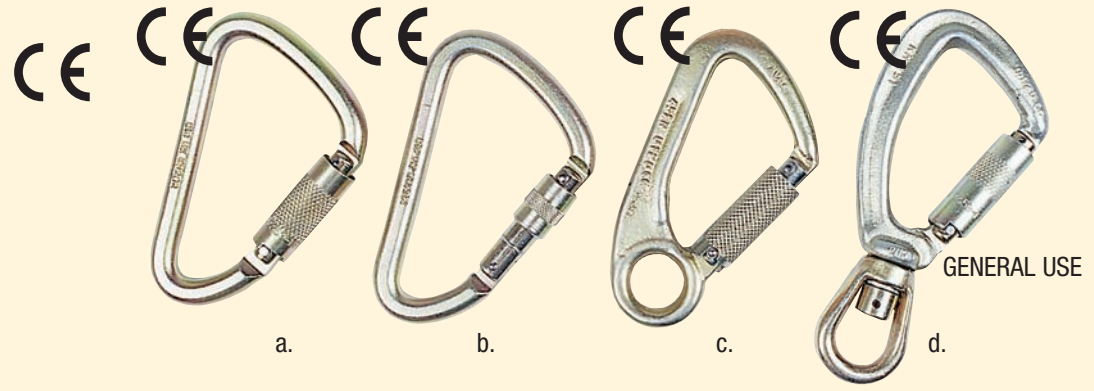

**Steel Carabiners and Autolocking Snap Hooks**

Stock Number	Description	Dimension (in.)	Gate (in.)	Strength (lbf.)	WLL** (lbs.)	Wgt (oz.)
a. 6053170	Klettersteig, Twistlock	5.0 x 3.0	1.0	10,000	1,000	9
b. 6053172	Klettersteig, Screwgate	5.0 x 3.0	1.0	10,000	1,000	9
6053171	Klettersteig, Supersafe	5.0 x 3.0	1.0	10,000	1,000	9
c. 6053198	Fixed Eye Steel, Twistlock	5.25 x 2.75	0.75	10,000	1,000	9.8
6053197	Fixed Eye Steel, Supersafe	5.25 x 2.75	0.75	10,000	1,000	10.1
d. 6053193	Swivel Eye Steel, Twistlock	7.0 x 3.5	1.0	10,000	1,000	15.3
6053194	Swivel Eye Steel, Supersafe	7.0 x 3.5	1.0	10,000	1,000	16.6

Meets OSHA, NFPA, CSA, BSI, DIN requirements.  
\*\*WLL - Recommended Working Load (also known as Safe Working Load) is calculated using the Industrial 10:1 critical use Safe Working Load Ratio.

Snaps are to be used in accordance with current ANSI / OSHA Fall Protection Standards.

**TECHNote™**

**TWISTLOCK vs. SUPERSAFE™**

Twistlock gates are the fastest gate locking mechanism to operate. It provides a convenient solution to eliminating the chance that the gate will accidentally be left unlocked. Supersafe gates are triple-action twistlock construction that requires three distinct movements to unlock the carabiner gate.

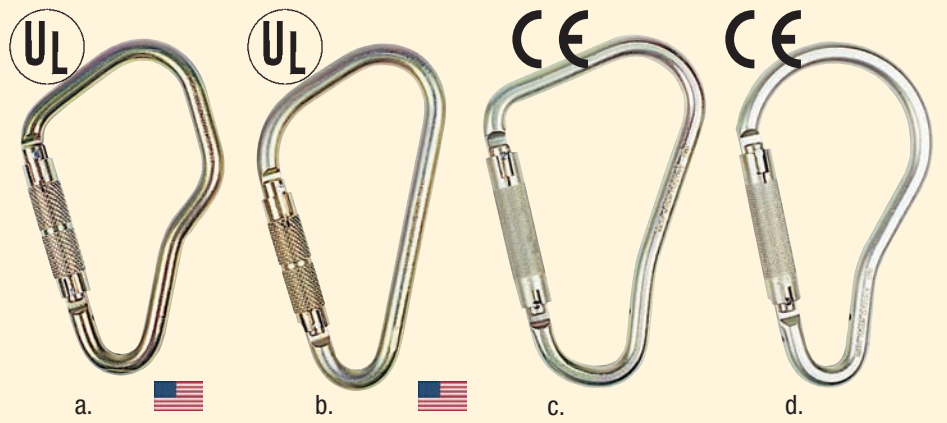
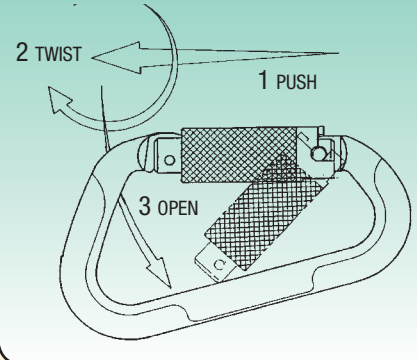

**Scaffold hooks**

Stock Number	Description	Dimension (in.)	Gate (in.)	Strength (lbf.)	WLL** (lbs.)	Wgt (oz.)
a. 6050180	Offset Scaffold Hook, Autolock*	7.9 x 4.6	2.1	11,200	1,120	669
b. 6050186	Ladder Hook, Autolock*	8.07 x 4.95	2.2	11,200	1,120	680
6050188	Ladder Hook, Screwgate*	8.07 x 4.95	2.4	11,200	1,120	680
c. 6053180	Offset Scaffold Hook, Twistlock	8.3 x 5.6	2.3	10,000	1,000	740
d. 6053184	Pear Scaffold Hook, Twistlock	8.8 x 4.7	2.1	7,800	780	744

\*Meets NFPA 1983. 3rd party certified by Underwriters Laboratories. Exceeds ANSI/OSHA strength requirements.

**WARNING**

Technical rescue and safety is potentially hazardous. Any person using equipment sold by RESCUE TECHNOLOGY in any manner is personally responsible for learning the proper techniques involved, and assumes all risks and accepts full and complete responsibility for any and all damages or injury of any kind, including death, which may result from the use of any RESCUE TECHNOLOGY equipment.

Captive Bar included with Scaffold Hooks is easily user-inserted into frame



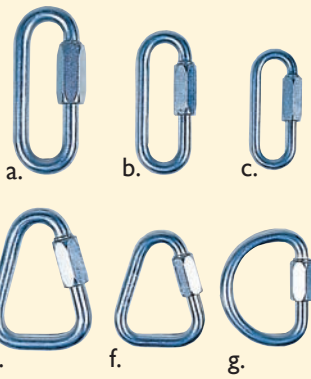

### M.R. Links

These links are often an inexpensive alternative to standard carabiners. They are most effective in applications for semi-permanent attachments. The Delta shape link is used where multi-directional loading is encountered. All the links are complete with a long threaded nut closure. Made in France.



### Offset D Aluminum with Captive Eye

Pin holds Search Lines in Place

Same shape and closure as our Offset D Autolock Carabiner. The additional of the pin helps keep ropes and cords situation at the base of the carabiner. No longer can your search line come off the carabiner by simply sliding out the gate opening.

Strength	6,745 lbf.	30 kN
WLL	675 lbs.	307 kg
Gate Opening	.787"	20mm
Dimensions	4.5 x 2.75"	113 x 69 mm
Weight	4 oz.	113.5 gm

6051273 Autolock w/ Captive Eye

Meets NFPA 1983/ANSI/OSHA strength requirements.

GALVANIZED		Dimensions (in)	Gate (in)	Strength (lbf.)	WLL (lbs.)	Rating
a. 60510112	12mm Widegate	4.875 x 4	15/16	13,780	1378	General
b. 60510110	10mm Widegate	4.125 x 1.75	13/16	11,020	1100	General
c. 60510108	8mm Widegate	3.5 x 1.5	11/16	7,165	700	Light
d. 60510214	14mm Delta	4.75 x 3.375	5/8	19,840	1984	General
e. 60510212	12mm Delta	4.125 x 3	19/32	12,125	1213	General
f. 60510210	10mm Delta	3.5 x 2.625	7/16	9,920	990	General
g. 60510310	10mm Semi-Circle	3.5 x 3	5/16	9,920	990	General
STAINLESS STEEL						
e. 60511212	12mm Delta	4.125 x 3	19/32	19,290	1920	General

Exceeds NFPA 1983/ANSI/OSHA strength requirements.

### WARNING

Technical rescue and safety is potentially hazardous. Any person using equipment sold by RESCUE TECHNOLOGY in any manner is personally responsible for learning the proper techniques involved, and assumes all risks and accepts full and complete responsibility for any and all damages or injury of any kind, including death, which may result from the use of any RESCUE TECHNOLOGY equipment.

### Rigging Swivels

Bearings Provide a Low Friction Rigging Tool

A handy tool for use where ropes or rigging must be free to rotate. Great for use in confined space rescues. Stainless Steel is stronger and more durable than comparable sized aluminum swivels.

		Length (in)	Strength (lbf.)	WLL (lbs.)	Opening Diam.	Wgt (oz.)
a. 606468**	Stainless Steel	4.5	10,000	1,000	3/4"	9.1
b. 606501**	CMI Axis™ Swivel	4.25	9,000	900	1.25"	5.5
c. 2354159*	Petzl Aluminum, Large	4.25	8,093	800	3/4"	5.2
d. 2354158	Petzl Aluminum, Small	3.75	5,000	500	1/2"	4.5

\*Certified NFPA 1983-G  
\*\*Meets NFPA 1983 Strength Specifications

### Quick Release Snap

Quick release under tension. Used where a line might have to be separated quickly from anchor during helicopter lifts, etc. NOT designed for continuous heavy duty use. Full size stainless steel construction.

		Bail Length	Strength Diameter	WLL (lbf.)	NFPA (lbs.)	Rating
606302	Heavy Duty	4 5/16"	5/8"	10,500	1,050	General



RESCUE TECH

www.rescuetechn1.com





LIGHT USE

## NFPA Aluminum Carabiners

Rescue Technology aluminum carabiners are designed with quality and utility in mind. Manufactured from high quality alloy aluminum, the sides of the standard size are flattened to give superior performance. Each carabiner is marked with its original strength and manufacturing batch. Certified by Underwriters Laboratories to NFPA 1983.

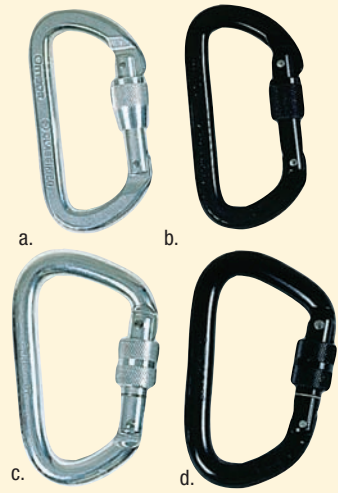

\*UL Certified to NFPA 1983 requirements.



Stock Number	Description	Color	Gate (in.)	Dimensions (in.)	Strength		WLL (lbs.)
					Major Axis	Open	
a. 6051250*	NFPA 'D' Screwgate	Silver	.625	4.1 x 2.1	6,070 lbf.	2020 lbf.	607
b. 6051251*	NFPA 'D' Screwgate	Black	.625	4.1 x 2.1	6,070 lbf.	2020 lbf.	607
c. 6050270	NFPA Offset 'D' Screwgate	Silver	.787	4.5 x 2.75	6,745 lbf.	2020 lbf.	675
d. 6050271	NFPA Offset 'D' Screwgate	Black	.787	4.5 x 2.75	6,745 lbf.	2020 lbf.	675
6050272	NFPA Offset 'D' Autolock	Silver	.787	4.5 x 2.75	6,745 lbf.	2020 lbf.	675
6050278	NFPA Offset 'D' Locksafe	Silver	.787	4.5 x 2.75	6,745 lbf.	2020 lbf.	675

LIGHT USE

## Aluminum Carabiners

Larger versions of our NFPA Aluminum carabiners provide a larger gate opening. The Jake is a traditional HMS style carabiner for those who need a large, smooth radius at one end. The Large 'D' is an aluminum version of our popular steel Large 'D' carabiner.

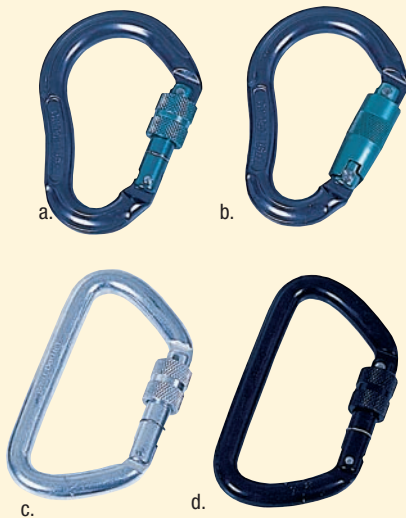

Stock Number	Description	Color	Gate (in.)	Dimensions (in.)	Strength		WLL (lbs.)
					Major Axis	Open	
a. 6050279	Jake HMS Screwgate	Gray	1.0	4.6 x 3.15	5,171 lbf.	1800 lbf.	517
b. 6050274	Jake HMS Autolock	Gray	.94	4.6 x 3.15	5,171 lbf.	1800 lbf.	517
6050259	Jake HMS Locksafe	Gray	.86	4.6 x 3.15	5,171 lbf.	1800 lbf.	517
c. 6051280	Large 'D' Screwgate	Silver	1	4.8 x 2.8	6,745 lbf.	2250 lbf.	675
d. 6051281	Large 'D' Screwgate	Black	1	4.8 x 2.8	6,745 lbf.	2250 lbf.	675

## ISO Cold Forged Carabiners

LIGHT USE

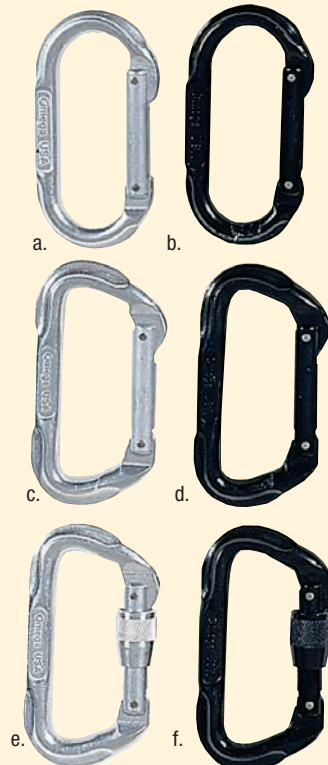

Stock Number	Description	Color	Gate (in.)	Dimensions (in.)	Strength		WLL (lbs.)
					Major Axis	Open	
a. 6050200	11mm Oval Non-Locking	Silver	.625	4.1 x 2.1	4,946 lbf.	1350 lbf.	494
b. 6050201	11mm Oval Non-Locking	Black	.625	4.1 x 2.1	4,946 lbf.	1350 lbf.	494
c. 6050210	'D' Non-Locking	Silver	.787	4.2 x 2.2	6,969 lbf.	2020 lbf.	697
d. 6050211	'D' Non-Locking	Black	.787	4.2 x 2.2	6,969 lbf.	2020 lbf.	697
e. 6050250	'D' Locking	Silver	.67	4.2 x 2.2	6,969 lbf.	2020 lbf.	697
f. 6050251	'D' Locking	Black	.67	4.2 x 2.2	6,969 lbf.	2020 lbf.	697

### TECHNote™

#### UNITS OF MEASUREMENT

Pounds and kilograms are units of weight measurement (i.e. mass under the influence of gravity). Foot Pounds & kiloNewtons are the correct measurement of the force it takes to break an object. The conversion formula is pounds force(lbf.) = kiloNewtons (kN) divided by .004448.

### TECHNote™

#### ANSI REGULATIONS

ANSI fall protection regulations state that "locking type snap hooks shall have a self-closing, self-locking keeper." This statement is normally interpreted as meaning only auto-locking carabiners (snap-hooks) meet the standard.





### Mini-Haul - Light

A mini 4:1 / 5:1 Hauling system for those time where you don't need to deploy your long ropes and heavy pulleys. Perfect for litter attendants, edge transitions, and much more. Comprised of our 3/8" ACCESS Lifeline (30'), RescueTECH Double Mini Pulley (2), OD50 Carabiners (2), Prusik Cord, and pouch (will attach to harness). Tested Strength to Prusik failure: 5,500 lbf., Ultimate Strength: 7,000 lbf. Light Use

- |        |           |
|--------|-----------|
| 614405 | Screwgate |
| 614406 | Autolock  |

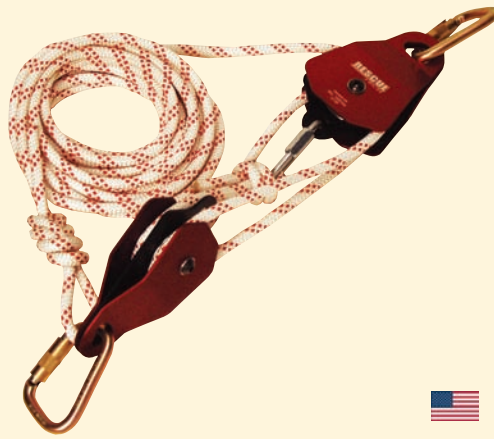

### Mini-Haul - General

A full-sized 4:1 / 5:1 Hauling System for all types of rescues. Perfect for load transfer, short haul distances, pre-rigs, and much more. Comprised of our 7/16" ACCESS Lifeline (30'), RescueTECH Double PMP (2), OD50 Carabiners (2), Prusik Cord, and pouch (will attach to harness). Ultimate Strength: 9,000 lbf. General Use

- |        |           |
|--------|-----------|
| 614412 | Screwgate |
| 614413 | Autolock  |



### Personal CSR / Transfer Kit Built-In Safety Cam

Great tool for rescuers transferring the victims load to a new rescue line. Can be used as either a 4:1 or 5:1 system. Works like a "power-assist" pick-off strap. Utilizes the Micro CSR Pulley for hauling safety. Complete with storage pouch that will attach to rescue harness. Maximum Lift: 48". Weight: 50 oz.

- |        |           |
|--------|-----------|
| 614433 | Autolock  |
| 614436 | Screwgate |



### Rescue System Change-Over Slings Great Addition To Pre-Rig Systems

Allows rescuers to extend a Z-rig past the lowering device without having to tie a "green" sling. Length: 15" Super Strong 8,500 lbf. WLL: 850 lbs.

- |         |                          |
|---------|--------------------------|
| 753105  | Dogbone Z-Rig Sling, 16" |
| 7531052 | Dogbone Z-Rig Sling, 21" |

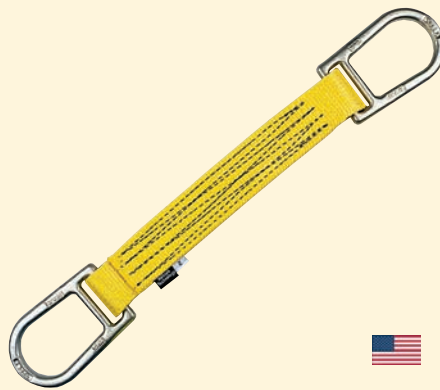

### Rescue System Change-Over Sling w/ "D" Great Addition To Pre-Rig Systems

Allows rescuers to extend a Z-rig past the lowering device without having to tie a "green" sling. Super Strong: 16,000 lbf.

- |        |                        |
|--------|------------------------|
| 753106 | Super H.D. Z-Rig Sling |
|--------|------------------------|



### 4:1 / 5:1 Extractor™ Load Transfer Kit

This kit is a mechanical advantage system that allows the user to safely transfer a load. It provides the security of a built-in safety cam. 4:1 Kit complete with 40 feet of rope for 10' of lift. Available with Autolocking or Screwgate carabiners.

- |        |                              |
|--------|------------------------------|
| 614422 | 4:1 Load Transfer, Autolock  |
| 614425 | 4:1 Load Transfer, Screwgate |

Meets NFPA 1983 / ANSI / OSHA strength requirements.



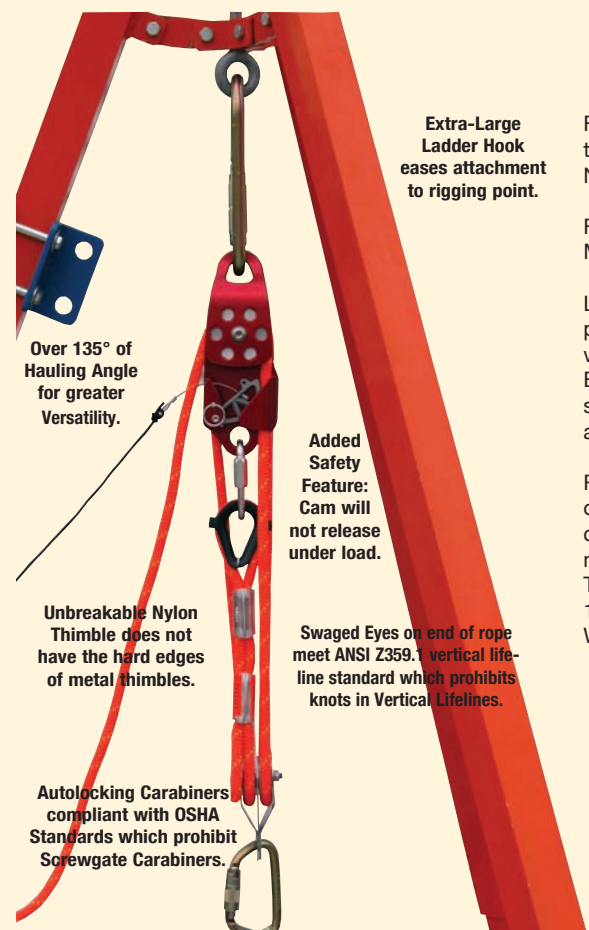

**Extra-Large Ladder Hook** eases attachment to rigging point.

Over 135° of Hauling Angle for greater Versatility.

**Added Safety Feature:** Cam will not release under load.

Unbreakable Nylon Thimble does not have the hard edges of metal thimbles.

Swaged Eyes on end of rope meet ANSI Z359.1 vertical lifeline standard which prohibits knots in Vertical Lifelines.

Autolocking Carabiners compliant with OSHA Standards which prohibit Screwgate Carabiners.

RT Extractor show with H.D. Tripod (not included with kit)

## System Rating: General Use

### 1/2" Extractor™ CSR Kit With Rope / Equipment Bag

614210	Basic 37 - 150 ft. of rope
614212	Basic 50 - 200 ft. of rope
614211	Deluxe 37 - 150 ft. of rope
614213	Deluxe 50 - 200 ft. of rope

### 7/16" Extractor™ CSR Kit With Vapor Tight Case

614202	Basic 25 - 100 ft. of rope
614204	Basic 50 - 200 ft. of rope
614203	Deluxe 25 - 100 ft. of rope
614205	Deluxe 50 - 200 ft. of rope

### 7/16" Extractor™ CSR Kit With Rope / Equipment Bag

614208	Basic 50 - 200 ft. of rope
614209	Deluxe 50 - 200 ft. of rope

## Extractor™ Confined Space Rescue Kit Confined Space Personnel Rescue Kit



**FOR RESCUE** Used as 4:1 Block and Tackle or "piggy-backed" onto main haul line. Decreases training needs for mechanical advantage systems. Great re-direct pulley with a built-in safety. No loss of haul due to slack in a prusik cord or external camming safety.

**FOR INDUSTRY** Easy to use. Meets OSHA 1910.146 Mechanical Retrieval Device standard. Meets ANSI Z359.1 vertical lifeline standards and autolocking carabiner requirements.

**LIFTING SAFETY** Unit works as a hauling system with a "deadman's" safety. Included safety pin holds cam in either open (rope will run freely in both directions) or in safety position. Rope will move in hauling direction only and cannot be removed or fall out when safety is engaged. Extractor™ may be used horizontally and can be attached to a haul-line to act as a 4:1 hauling system. 1/2" version available in 37 ft. and 50 ft. lift capacity. 7/16" version available in 25 ft. and 50 ft. lift capacity.

**REMOTE LOWERING CAPABILITY** The attached cable allows remote control of the safety cam. This makes it possible to place the Extractor™ unit where it cannot be directly accessed. Extractor™ design provides over 135° of hauling line movement. It does not limit hauling team to standing "in-line" with the rope system. The pulley sheaves are equipped with Oilite™ bushings and will accept ropes up to 1/2" diameter. The Extractor™ frame is constructed of high tensile aluminum alloy. WLL: 1,000 lbs. Dimensions: 9" x 3". Color: Red.

#### All Kits include:

- ACCESS Lifeline w/ swaged eye
- EXTRACTOR™ CSR Pulley
- Double Pulley
- Autolocking Carabiners
- Carrying Case / Bag

#### Deluxe Kits also include:

- Fall Protection Harness
- Lifting Bridle



Extractor Kit with Case



Extractor Kit with Bag.



## ▲ WARNING

Technical rescue and safety is potentially hazardous. Any person using equipment sold by RESCUE TECHNOLOGY in any manner is personally responsible for learning the proper techniques involved, and assumes all risks and accepts full and complete responsibility for any and all damages or injury of any kind, including death, which may result from the use of any RESCUE TECHNOLOGY equipment.





**NEW**

### Confined Space Rescue Set

Designed to provide a 2-person team with a set of equipment that allows for the rescue of victims. Comes complete with Tripod and Extractor CSR Kit for an anchor point and retrieval system. A separate belay may be set up with the included Petzl I'd Belay device and 150 ft. section of 1/2" ACCESS Lifeline. Rigging equipment and edge protection is also included. All personal and team equipment, as well as hardware and tripod storage is included.

2998123

- |    |  |   |  |
|----|--|---|--|
| 2  | EOS Headlamp                           | 1 | Load Release Sling                       |
| 2  | Vertex Vent Helmets                    | 1 | 11mm Aluminum Carabiner, Screwgate       |
| 2  | Rope Technician Glove, Pr              | 1 | Remote Retrieval Hook                    |
| 2  | Vanguard Class III Rescue Harness      | 1 | Extractor Pole, 12'                      |
| 1  | Technician Tripod w/ Tripod Bag        | 1 | RescueTECH Edge Pad, Wide                |
| 1  | Petzl I'D Belay Device                 | 2 | RescueTECH Rope Guard, 24" (Red)         |
| 1  | 1/2" ACCESS Lifeline x 150 ft. (Blue)  | 1 | RescueTECH Rope Bag, Medium (Blue)       |
| 1  | Technical Rescue Rigging Plate         | 1 | Rescue TECH Deluxe Equipment Pack (Blue) |
| 10 | OD50 Steel Carabiners, Screwgate       | 2 | RescueTECH Duffie Bag, Large (Blue)      |
| 1  | RescueTECH PMP, Bushing                |   |  |
| 1  | 1/2" Extractor CSR Kit w/ Bag, 150 ft. |   |  |
| 2  | Rigging Sling w/ D, 8 ft.              |   |  |

*Items shown for illustration purposes - Not to Scale.  
Items subject to change if new/improved components become available.*

### Spin-Lock Rescue / Retrieval System Locking Pulley for Combination Raise / Lower System

The Spin-Lock Rescue system is a pre-rigged 4:1 Hauling system that utilizes a unique pulley with sheaves that rotate in only one direction. When properly rigged, this system works as an efficient 4:1 mechanical advantage pulley system that also provides friction to control the load when in lowering mode. The special sheave are mounted on a unique one-way bearing that allows the user to easily control a rescue load. Also, included is a Handled Ascender to control and anchor the system when at rest. The attached foot loop also aids the rescue in raising heavier loads.

The Spin-Lock Rescue / Retrieval Kit is a pre-rigged kit that combines the RescueTECH Remote Retrieval Hook and Extension Pole access system with a Spin-Lock Rescue / Retrieval system. The remote hook and extension pole allows for non-entry remote attachment of a rescue lifeline to a victim in a confined space or vertical environment.

- |          |                          |          |                       |
|----------|--------------------------|----------|-----------------------|
| 29984401 | Spin-Lock System 50 ft.  | 29984421 | Spin-Lock Kit 50 ft.  |
| 29984402 | Spin-Lock System 75 ft.  | 29984422 | Spin-Lock Kit 75 ft.  |
| 29984403 | Spin-Lock System 150 ft. | 29984423 | Spin-Lock Kit 150 ft. |

## TECHNote™

### STEEL vs. ALUMINUM CARABINERS

1. Steel is more wear-resistant than aluminum.
2. Steel carabiners are more ductile, thus allowing a greater amount of energy to be absorbed by the carabiner prior to failure.
3. The ductility also helps the carabiner be more resistant to misuse such as non-straight line loading.
4. Steel carabiners are inherently more resistant to corrosion in alkaline environments.
5. Aluminum alloy carabiners are not suitable for use in combustible environments. D.I.N. recommends and B.S. 1397 specifies that steel carabiners be used in explosive environments. When aluminum and steel oxides combine, very high temperature spark is produced. The steel-to-steel contact sometimes cause a low temperature spark, but no data to show that this will ignite atmospheres.



Remote Retrieval Hook and Extension Pole included in Kit ONLY

**RESCUE TECH**

www.rescuetechn1.com





### Rope Access Technician Equipment Set

A simple set of personal equipment for basic Rope Access work.

- 1 Micro Pulley
- 2 Shunt
- 1 Vertex Vent Helmet
- 1 Petzl I'D Small
- 1 "I" Lanyard, 24"
- 1 "I" Lanyard, 32"
- 1 Pro Leather Glove, Pair
- 1 Handled Ascender
- 1 Chest Ascender
- 2 Adjustable Foot Sling
- 10 Aluminum Offset D Carabiner
- 2 6mm Rapid Link
- 1 10mm Tri-Link
- 1 Vanguard Class III Harness
- 1 RescueTECH Gear pack

29982013

## TECHNote™

### RT Pulley Design

New this year is our full line of Rescue Technology Technical rescue pulleys. These pulleys are built to last. Most of our pulleys are designed without the double bend sideplates found on most pulleys and replaces them with a continuous radius bend. This bend prevents the "un-springing" of the sideplates found in traditional double bend sideplates. The Rescue Technology pulleys also feature weight reducing holes in the sideplates. Most of our pulleys also will accommodate ropes up to 5/8" (16mm). This capacity means that one pulley will handle all of today's NFPA General and Light Use ropes.



### Rescue Anchor Set

We have packaged two of our Heavy Duty Anchor Straps with a Wear Guard and Delta Rapid Link to give rescuers a quick, secure, and hard wearing anchor sling set. Includes storage bag.

- 29982101 Large, 8' Anchor Slings
- 29982102 Medium, 6' Anchor Slings



### Basic Water Rescue Set

The bare minimum equipment to have while working around water. Includes U22 Pro PFD, River Rescue Short Knife, Fox Mini Whistle, 3/8" Throwbag x 50 ft., and Mesh storage bag.

Lanyard Not Included

- 29982003 Basic Water Rescue Set

**⚠ WARNING**

Technical rescue and safety is potentially hazardous. Any person using equipment sold by RESCUE TECHNOLOGY in any manner is personally responsible for learning the proper techniques involved, and assumes all risks and accepts full and complete responsibility for any and all damages or injury of any kind, including death, which may result from the use of any RESCUE TECHNOLOGY equipment.



### 12' Self-Bailing Raft Set

A basic Set of Raft Equipment that includes what an existing water rescue team needs for boat operations. Large, wide raft for excellent stability. Self-Bailing Function keeps water from filling up and capsizing the raft.

- 29981012
- 1 12' Self Bailing Raft w/ 2 thwart
- 1 72" Paddle
- 4 60" Paddles
- 1 12vDC Electric Inflator
- 1 Manual Barrel Pump Inflator
- 1 Raft Repair Kit





### 4:1 Hauling Kit Block and Tackle System

Complete hauling kits that are ready to use. Each kit contains 1/2" Rescue rope & prusik cord, high strength pulleys, Gibbs Ascenders and RescueTECH Carabiners complete the system. 4:1 Block and Tackle pulley system is packaged in Rope and Equipment Bag, and is ready for the rescuer to simply reach in and grab the carabiner to attach to the rigging point.

- 610604 4:1 Hauling Kit, 150 ft.
- 610624 4:1 Hauling Kit, 200 ft.

*Meets NFPA 1983/ANSI/OSHA strength specifications.*



### Z-Rig Haul Set

RescueTECH equipment packaged in a ready-to-rig 3:1 Z-Rig system. Includes: Pulleys, Rope Grab, Prusik, Carabiners, Rope and Storage Bag.

- 29984151150 150'
- 29984151200 200'



### USAR Pack Rescue Set

An equipment set designed to provide equipment for basic rigging, access, and rescue.

- |                                 |                              |
|---------------------------------|------------------------------|
| 1 1/2" NFPA Rope*               | 2 Anchor Sling, 8 ft.*       |
| 8 Rigger Large D Carabiner*     | 2 Anchor Sling w/ D, 6 foot* |
| 2 Gibbs Ascender, Free Running* | 2 2.5 PMP Rescue Pulley*     |
| 1 1/2" Rescue Ascender*         | 1 2" H.D. Single Pulley*     |
| 1 NFPA Rescue 8 Descender*      | 2 Rope Guard, 18"            |
| 1 Rescue Rack*                  | 1 USAR Rope & Equipment Pack |

- |                      |                      |
|----------------------|----------------------|
| 350526 150 ft., Blue | 350536 200 ft., Blue |
| 350524 150 ft., Red  | 350535 200 ft., Red  |

*\*Meets NFPA 1983/ANSI/OSHA strength specifications.*



### Raise / Lower Set

Equipment set-up popular at many state fire/rescue academies. Sufficient for a Z-Rig Raise and Rack Lower System.

- |                             |                          |
|-----------------------------|--------------------------|
| 1 1/2" NFPA Rescue Rope*    | 2 8mm Cord x 5 ft.       |
| 2 10' Anchor Sling*         | 1 8mm Cord x 6 ft.       |
| 5 Large D Steel Carabiners* | 1 Dogbone Rigging Sling* |
| 1 Rigging Plate*            | 1 Equipment Saddlebag    |
| 1 Rescue Rack*              | 1 Rope Bag               |
| 2 PMP Rescue Pulley*        |                          |

*\*Meets NFPA 1983/ANSI/OSHA strength specifications.*

- |                      |
|----------------------|
| 29982120 200' System |
| 29982130 300' System |



## Deluxe Equipment Pack Set

A set of equipment designed to meet the basic needs of rescuers. Use this set of equipment with two life safety ropes and create a raise / lower system with belay system. Multiple mechanical advantage systems can be built as well as specialized rigging systems.

29983420



- |   |                  |    |                     |   |                       |
|---|------------------|----|---------------------|---|-----------------------|
| 2 | 8mm Prusik x 5'  | 10 | RD70 Carabiner, S/G | 2 | Anchor Sling w/ D, 6' |
| 2 | 8mm Prusik x 6'  | 3  | 2.5" Single PMP     | 2 | 1" H.D. Web x 20'     |
| 1 | Rescue Rack      | 3  | 2.5" Double PMP     | 1 | 1" H.D. Web x 25'     |
| 1 | Aluminum D, S/G  | 2  | Rope Guard, 18"     | 1 | Load Release Strap    |
| 1 | Delta Rapid Link | 2  | Anchor Sling, 8'    | 1 | Deluxe Equip. Pack    |



## USAR Pack Deluxe Rescue Set

An equipment set designed to provide equipment for basic rigging, access, and rescue. Set is comprised of:

- |    |                                |        |                        |
|----|--------------------------------|--------|------------------------|
| 1  | 1/2" NFPA Rope x 200 ft.       | 2      | Red HD Web, 25 ft.     |
| 12 | RescueTECH Large D Carabiner   | 2      | Orange HD Web, 20 ft.  |
| 2  | Gibbs Ascender, Free Running   | 2      | Blue HD Web, 15 ft.    |
| 2  | 1/2" Rescue Ascender           | 2      | Yellow HD Web, 12 ft.  |
| 1  | NFPA Rescue 8 Descender        | 2      | Green HD Web, 5 ft.    |
| 1  | Rescue Rack                    | 4      | 8mm Prusik Cord, Long  |
| 4  | Anchor Sling w/ D, 6 foot      | 4      | 8mm Prusik Cord, Short |
| 4  | 2.5 PMP Rescue Pulley          | 1      | USAR Pack              |
| 1  | 2/5" Double PMP Rescue Pulley  |        |                        |
| 2  | Rope Guard, 18"                | 350566 | Blue                   |
| 1  | Delta Rapid Link               | 350564 | Red                    |
| 1  | Technical Rescue Rigging Plate |        |                        |
| 1  | 10" Steel Cable Sling          |        |                        |

Meets NFPA 1983/ANSI/OSHA strength specifications.

Bag Tether secures bag to tower allowing rescuer to more easily perform the rescue

RescueTECH Load Transfer System moves the rescue load onto the Tower Rescue System

Adjustable Rigging sling attaches Tower System to virtually all towers.

Internal Compartment keeps Transfer and Lowering Systems separated from Rope.

Anthron Lowering Device controls load.

System attaches to victim with Autolocking Carabiner.

## Tower Rescue System

A Rescue Technology original. Specially designed pack and rescue system allows one-handed rigging, rescue and lowering of patient. Packaged in a RescueTECH Tower Rescue Pack. Pack is designed to allow one-hand-attachment to tower and one-hand detachment of shoulder straps. Adjustable Rigging Sling easily secures Transfer and Lowering Systems to the tower. Transfer system allows rescuer to move the patient onto the rescue system. Load is lowered using Anthron Lowering device. Features Certified NFPA 3/8" Rescue rope.

29982156 Tower Rescue System, 300 ft.

# RESCUE TECH

www.rescuetechn1.com





**RescueTECH  
2" NFPA Single**  
*For Ropes Up to 1/2" Diameter*

A pulley that works well for all rescue and work needs.

Dimensions	4.25" x 2.5"
Strength	9,000 lbf.
WLL	900 lbs.
Weight	7.5 oz

**610721** RT 2" Single, Bushing

*Meets NFPA 1983/ANSI/OSHA strength specifications.*



**RescueTECH  
3" NFPA Single**  
*For Ropes Up to 5/8" Diameter*

A new high-strength, long wearing design. Sideplate bend to the 3 carabiner rigging point reduces flexing and stresses put on bends during high load. 3/16" sideplates are designed to protect the rope as it travels through the pulley. In fact, a 5/8" diameter rope is protected by the sideplates from edge abrasion.

Dimensions	6.25" x 3.75"
Strength	11,241 (50 kN)
WLL	1,124 lbs.
Weight	16 oz.

**610731** RT 3" Single Bushing

*Meets NFPA 1983/ANSI/OSHA strength specifications.*



**RescueTECH  
3" NFPA Double**  
*For Ropes Up to 5/8" Diameter*

The matching Double Pulley to our new RT 3" Single. Complete with Becket Rigging point.

Dimensions	7.25" x 3.75" x 2.325"
Strength	11,241 lbf.
WLL	1124 lbs.
Weight	24 oz.

**610732** RT 3" Double, Bushing

*Meets NFPA 1983/ANSI/OSHA strength specifications.*



**RescueTECH  
2" NFPA Double**  
*Matching Pulley for our Extractor CSR*

Designed for ropes up to 1/2" Diameter. High strength and lightweight makes this the ideal multi-use pulley for rescue.

Dimensions	5" x 1.75"
Strength	9,000 lbf
WLL	900 lbs.
Weight	12 oz.

**610722** RT 2" Double, Bushing

*Meets NFPA 1983/ANSI/OSHA strength specifications.*



**RescueTECH  
Micro Pulley**

A strong pulley in a small package. Made from alloy aluminum, this pulley is perfect for a variety of rescue uses. From Tower Rescue to Water Rescue the RT Micro is one of the most versatile pulleys around. Made for ropes 5/16" - 7/16" Diameter.

	Single	Double
Dimensions	2.9 x 1.75"	3.5 x 1.75 x 1.9"
Strength	7,868 lbf	7,868 lbf.
Weight	2.9 oz.	5.1 oz.

**6101151** RT Micro - Black

**6101154** RT Micro - Red

**6101284** RT Micro Double - Red

*Meets NFPA 1983/ANSI/OSHA strength specifications.*



**RescueTECH  
Spin-Lock Pulley**  
*Uni-Directional Pulley.*

Great for raise / lower systems. Pulley sheave turn one direction making hauling easy and providing friction as the rope is belayed through the device.

Dimensions	6.7" x 3.3" x 2.4"
Strength	10,120 lbf.
WLL	1,120 lbs.
Weight	26 oz.
Color	Red

**2014700** RT Spin Lock Pulley

*Meets NFPA 1983/ANSI/OSHA strength specifications.*



## RescueTECH Extractor™ CSR Hauler

The EXTRACTOR™ CSR HAULER pulley features an integral safety cam to secure the progress of hauling systems. The first in a series of Rescue Technology pulleys that meet the rugged requirements of Rope Rescue Technicians, the EXTRACTOR™ CSR HAULER is designed for 1/2" Life Safety rope and will accommodate ropes from 3/8" - 9/16". Special safety cam design is rope friendly and can be locked out of the way when a standard double pulley is needed. Super-strong, the EXTRACTOR™ CSR HAULER has an 1,100 lb. safe Working Load Limit.

614024	RT Extractor CSR, Double
614014	RT Extractor CSR, Single

Meets NFPA 1983/ANSI/OSHA strength specifications.

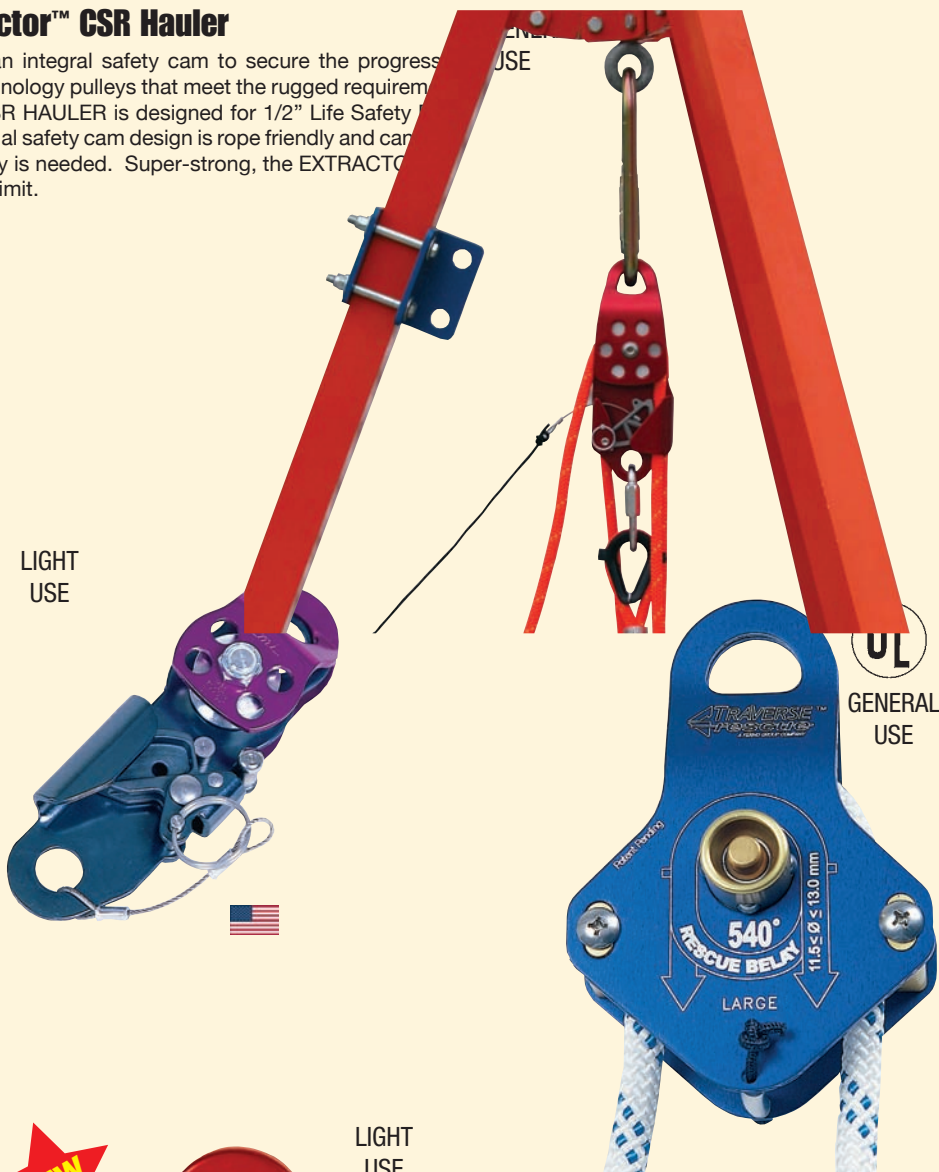

### Micro CSR Pulley

The perfect size for light use and tower rescues. Ideal for 8mm - 7/16" ropes. Works with ropes up to 1/2". Built-in safety cam holds rope for use in "Jigger" or "Short-Haul" Systems.

Strength	7,000 lbf.	31 kN
WLL	700 lbs.	318 kg
Dimensions	6" x 2"	152 x 51mm
Weight	8 oz.	226 gm
Color	Purple	

614321 Micro CSR Pulley

Meets NFPA 1983/ANSI/OSHA strength specifications.

LIGHT  
USE

UL  
GENERAL  
USE

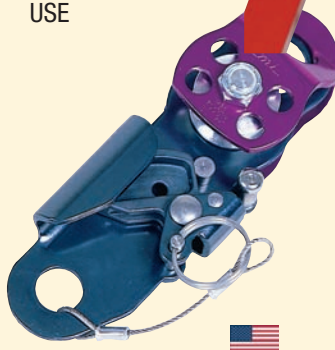

### 540° Rescue Belay

A mechanical belay device specifically engineered for fire service and industrial rescue teams. Simple and easy to use. Symmetrical design allows for bi-directional loading. Self-locking with sudden falls. Built-in release lever eliminates need for release hitch. Passes rescue belay competence criteria. Strength: 9,000 lbf. Weight: 24 oz. UL Certified NFPA 1983. 1 year manufacturer's warranty.

2154540	Large (11.5 - 13mm)
2154541	Small (10.6 - 11.6mm)
899522	540 Belay Video

LIGHT  
USE

LIGHT  
USE



### Micro Strap Pulley

#### Economical Personal Use Pulley

Simple Sideplate design provides extra safety for rescuers. Ideal for 8mm - 7/16" ropes.

Strength	4946 lbf.	22 kN
WLL	495 lbs.	225 kg
Dimensions	3.2" x 1.8"	82 x 45mm
Weight	3.35 oz.	95 gm
Color	Red	

2014037 Micro Strap Pulley

Meets NFPA 1983/ANSI/OSHA strength specifications. BS EN 12278

### Micro Pulley

#### Lightweight Snatch Block Design

The perfect size for light use and tower rescues. Ideal for 8mm - 7/16" ropes. Works as PMP pulley. Sheave Diameter: 1.25". Tread Diameter: 1.1".

Strength	4946 lbf.	22 kN
WLL	495 lbs.	225 kg
Dimensions	3.2" x 1.2"	82 x 30mm
Weight	4.3 oz.	122 gm
Color	Red	

2014038 Micro Pulley

## WARNING

Technical rescue and safety is potentially hazardous. Any person using equipment sold by RESCUE TECHNOLOGY in any manner is personally responsible for learning the proper techniques involved, and assumes all risks and accepts full and complete responsibility for any and all damages or injury of any kind, including death, which may result from the use of any RESCUE TECHNOLOGY equipment.

RESCUE TECH

www.rescuetechn1.com



GENERAL USE



### 2.5" Single Prusik Minding Pulley

Strength	9,000 lbf.	40 kN
WLL	900 lbs.	454.5 kg
Dimensions	6.6" x 4.6"	168 x 117mm
Weight	12 oz.	340 gm

610634 2.5" Single, Bushing (Blue)

Meets NFPA 1983/ANSI/OSHA strength specifications.

GENERAL USE



### 2.5" Double Prusik Minding Pulley

Strength	10,000 lbf.	46.7 kN
WLL	1,000 lbs.	477 kg
Dimensions	7" x 4.6"	178 x 117mm
Weight	24 oz.	681 gm

610644 2.5" Double, Bushing

Meets NFPA 1983/ANSI/OSHA strength specifications.

GENERAL USE



### Extra-Large Prusik Minding Pulley For 5/8" Rope

Strength	11,240 lbf.	50 kN
WLL	1,124 lbs.	511 kg
Dimensions	6.1" x 4.1"	156 x 106mm
Weight	15.7 oz.	446 gm

6107018 XL PMP (Red)

Meets NFPA 1983/ANSI/OSHA strength specifications.

LIGHT USE



### Rescuetech Micro PMP Pulleys

A smaller version of our popular PMP Pulleys. Designed for use with smaller ropes in load transfer systems or small haul rigs. Rating: Light Use.

	Single		Double	
	Strength	7,000 lbf.	31 kN	7,000 lbf.
WLL	700 lbs.	318 kg	700 lbs.	318 kg
Dimensions	3" x 2.5"	76.2 x 63.5mm	3.75" x 2.5"	95.2 x 63.5mm
Weight	3.2 oz.	91 gm	4.8 oz.	136 gm

610137 Single, Bushing (Gold)  
610137D Double, Bearing (Blue)

GENERAL USE

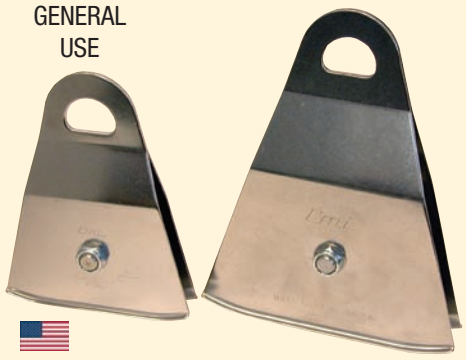

### Stainless Steel PMP Pulleys

Super-durable, corrosion-resistant Prusik Minding Pulleys. Tough Stainless Steel Sideplates with alloy aluminum sheave and oil-impregnated bushing.

Stock Number	Description	Dimensions		Wgt (oz.)	Strength (lbf.)	WLL (lbs.)	Max Rope Dia.	
		(in.)	(mm)				(in.)	(mm)
610138	4" PMP, Bushing	8.7 x 7	215 x 155	42	15,000	1500	5/8	16
610129N	3" PMP, Bushing	7 x 5	155 x 120	15.25	16,000	1600	1/2	13





GENERAL  
USE



## Aluminum Single Rescue Pulleys

Designed for ropes up to 5/8" diameter. Ultra-lightweight sheave fitted with Oilite® bushing or sealed bearing and rotating high strength alloy aluminum sideplates. Triangular rigging hole accepts up to three 13mm carabiners. Can use a Big Hook carabiner as becket rigging point for mechanical advantage hauling systems.

### 2" Rescue Pulley

Strength	10,000 lbf.	44.5 kN
WLL	1,000 lbs.	455 kg
Dimensions	5.25" x 2.25"	131 x 56mm
Pitch Dia.	1.5"	37.5mm
Weight	8.6 oz.	244 gm
Color	Blue	

610012	Oilite® Bushing
610012B	Sealed Bearing

Meets NFPA 1983/ANSI/OSHA strength specifications for Pulleys

### 3" Rescue Pulley

Strength	10,000 lbf.	44.5 kN
WLL	1,000 lbs.	455 kg
Dimensions	7" x 3"	175 x 75mm
Pitch Dia.	2.3"	57.5mm
Weight	14 oz.	397 gm
Color	Orange	

610013	Oilite® Bushing
610013B	Sealed Bearing

Meets NFPA 1983/ANSI/OSHA strength specifications for Pulleys



GENERAL  
USE



## Knot Passing Pulley Ideal For Use As Carriage Pulley

Heavy duty knot passing pulley. Rotating sideplates and a rigging point that will accommodate three 13mm rescue carabiners. Aluminum pulley sheave with Oilite® Bushing for durability. The Wide Pulley is designed for ropes up to 1/2" diameter. The large hole in center of the sideplates will accept a Big Hook carabiner for balanced hauling when unit is used as the top support pulley in rope traverse systems. Pitch Diameter: 2". Dimensions-Medium: 8" x 3" x 3.5". Strength: 10,000 lbf. WLL: 1000 lbs. Weight: 21 oz. Color: Red.

610015	Medium
610016	XLarge

Meets NFPA 1983/ANSI/OSHA strength specifications for Pulleys

## TECHNote™ BEARING vs. BUSHING

In rescue loads, the friction difference between bushings and bearings is minimal. It is only with loads that are greater than 5,000 lbf. that you begin to see the difference in friction. Ball bearings can dent the bearing race (brinelling). Sealed bearings can become contaminated with grit and seize. Oil Impregnated bronze bushings are stronger because there is a constant interface between the shaft, bushing, and pulley sheave. The bronze bushing is made from a soft material that will conform to the contaminant. Additionally, pulleys with bushings can be taken apart and cleaned.

## ▲ WARNING

Technical rescue and safety is potentially hazardous. Any person using equipment sold by RESCUE TECHNOLOGY in any manner is personally responsible for learning the proper techniques involved, and assumes all risks and accepts full and complete responsibility for any and all damages or injury of any kind, including death, which may result from the use of any RESCUE TECHNOLOGY equipment.



GENERAL  
USE

## Kootenay Pulley

Designed for passing knots in rope.

- High efficiency sealed ball bearings.
- Locking pins allow use as an anchor.
- Fits ropes from 5/16" to 3/4".
- Breaking strength: 8,992 lbf.
- Height: 10.25"
- Weight: 49 oz.
- Individually tested

2354067	Kootenay Pulley
---------	-----------------

Meets NFPA 1983/ANSI/OSHA strength specifications for Pulleys

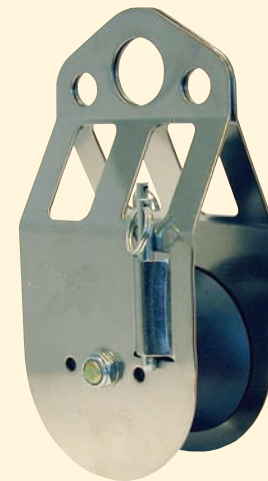

GENERAL  
USE



## Stainless Steel Carriage Pulley

The most versatile Knot-Passing / Highline pulley yet. Extra-wide 3" sheave easily passes knots in 1/2" rope. Large center rigging hole accepts up to three large carabiners, two smaller holes provide tagline attachments. Pins stowed directly on sideplates install to lock the sheave, allowing the pulley to be used as a high-strength tie off. Weight: 24.6 oz.; Dimensions: 10" x 5"; Efficiency: 91.4%; Strength: 15,000 lbs.

6102128	S.S. Carriage Pulley
---------	----------------------

Meets NFPA 1983/ANSI/OSHA strength specifications for Pulleys





GENERAL USE

## Stainless Steel Lite Pulley

High strength pulleys designed for ropes up to 5/8" diameter. 3" sheave diameters. Features high grade stainless steel sideplates and aluminum pulley sheave. Extra large rigging point accepts two rescue carabiners. Available with bronze bushing or sealed needle bearing.

Stock Number	Description	Dimensions		Wgt (oz.)	Strength (lbf.)	WLL (lbs.)	Max Rope Dia.		
		(in.)	(mm)				(in.)	(mm)	
6102005	3" Lite - Bushing	6.4 x 4	160 x 100	20	16,000	1600	5/8	16	
6102006	3" Lite - Bearing	6.4 x 4	160 x 100	20	16,000	1600	5/8	16	
6102005D	3" Double-Bushing	7.25 x 4.25	184 x 108	37	20000	2000	5/8"	16	



GENERAL USE

## Stainless Steel Single Pulley

Built to be tough and durable at an economical price. Plain sideplates with rigging points that accommodate two rescue carabiners. Stainless Steel sideplates and axle for extra durability. Available with sintered bronze bushing or needle bearing.

Stock Number	Description	Dimensions		Wgt (oz.)	Strength (lbf.)	WLL (lbs.)	Max Rope Dia.		
		(in.)	(mm)				(in.)	(mm)	
6102118	2" Bushing, Steel	5 x 2.5	125 x 63	11.6	8,000	800	1/2	13	
6102118A	2" Bushing, Alum.	5 x 2.5	125 x 63	7.7	8,000	800	1/2	13	
6102122	4" Bushing, Alum.	8 x 4.5	200 x 112	35	20,000	2000	5/8	13	
6102123	4" Bearing, Alum.	8 x 4.5	200 x 112	35	20,000	2000	5/8	13	

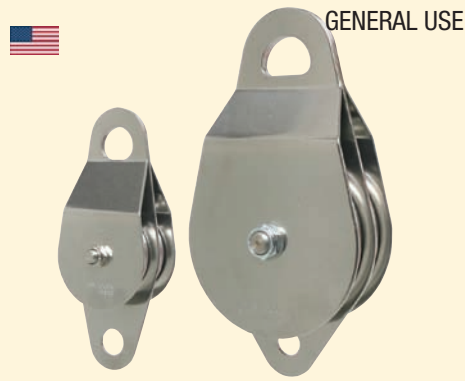

GENERAL USE

## Stainless Steel Double Pulley

Heavy Duty Stainless Steel Sideplates with aluminum sheaves. Available with sintered bronze bushing or needle bearing. Rating: General Use.

Stock Number	Description	Dimensions		Wgt (oz.)	Strength (lbf.)	WLL (lbs.)	Max Rope Dia.		
		(in.)	(mm)				(in.)	(mm)	
6102119	2" Bearing, Aluminum	6.5 x 2.5	162 x 62	13	11,000	1200	1/2	13	
6102120	2" Bushing, Steel	6.5 x 2.5	162 x 62	20	11,000	1200	1/2	13	
6102120A	2" Bushing, Aluminum	6.5 x 2.5	162 x 62	13	11,000	1200	1/2	13	
6102124	4" Bushing, Aluminum	9 x 4.5	225 x 112	60	25,000	2500	5/8	16	



GENERAL USE

## Single Pulley with Becket

Specialized rigging pulleys with stainless steel sideplates and either an aluminum or steel sheave, with bearing or bushing. The aluminum sheave models are ideal in rescue situations for use with rope. By using the extra rigging hole at the bottom of the pulley, they can be daisy-chained together in block and tackle fashion. Steel sheave models are great for use with steel cable or rope. In high line situations, the extra hole can be clipped together for an extra margin of safety. Rating: General Use.

Stock Number	Description	Dimensions		Wgt (oz.)	Strength (lbf.)	WLL (lbs.)	Max Rope Dia.		
		(in.)	(mm)				(in.)	(mm)	
6102111	2" Bushing, Aluminum	5.75 X 3	144 x 75	11	8,500	850	1/2	13	

**▲ WARNING**

Technical rescue and safety is potentially hazardous. Any person using equipment sold by RESCUE TECHNOLOGY in any manner is personally responsible for learning the proper techniques involved, and assumes all risks and accepts full and complete responsibility for any and all damages or injury of any kind, including death, which may result from the use of any RESCUE TECHNOLOGY equipment.

GENERAL  
USE



Left to Right: 2" NFPA Single, 4" NFPA Single



Left to Right: 2" NFPA Double(not available), 4" NFPA Double



### NFPA Stainless Steel Pulleys

Meets Construction and Strength Requirements of NFPA 1983

Stock Number	Description	Dimensions		Wgt (oz.)	Strength (lbf.)	WLL (lbs.)	Max Rope Dia.	
		(in.)	(mm)				(in.)	(mm)
6103117	2" Single, Bearing	5 x 2.5	125 x 63	7.7	8,000	800	1/2	13
6103118A	2" Single, Bushing	5 x 2.5	125 x 63	7.7	8,000	800	1/2	13
6103122	4" Single, Bushing	8 x 4.5	200 x 112	35	20,000	2000	5/8	16
6103123	4" Single, Bearing	8 x 4.5	200 x 112	35	20,000	2000	5/8	16
6103124	4" Double, Bushing	9 x 4.5	225 x 112	64	25,000	2500	5/8	16
6103125	4" Double, Bearing	9 x 4.5	225 x 112	64	25,000	2500	5/8	16



### Easy Lift Evacuation Pulley

For Ski Lift Rescues

Designed to be connected directly to the main ski lift cable for lift evacuations. Manufactured of alloy aluminum body, nylon sheave, and stainless steel gate. Must be used with back-up lanyard and belay system. Weight: 1420 gm. Strength: 30 kN. Works on cable up to 55mm.

23896104



### Stainless Steel Trolley Pulley

For Steel Cables

Sheaves turn on Sealed Ball Bearing for smooth, wobble-free use. Oversized stainless steel sideplates extend well beyond the sheaves to protect them from hard use. A rear slot allows a steel carabiner to surround the cable, allowing redundancy from the cable to the load. Dual Hardened Sheaves that will accommodate 3/8" or 1/2" cable.

6102221 Steel Cable

GENERAL USE



### Triple Sheave Pulley

The only aluminum triple sheave pulley with rotating sideplates. Designed for 7/16" - 5/8" ropes. Can be reeved at any point on the line. High strength alloy aluminum construction with Oilite® Bushing or Sealed Bearing. Triple carabiner rigging point. Tensile Strength: 15,000 lbf. WLL: 1,500 lbs. Dimensions: 10" x 4" x 4.5". Pitch Diameter: 3.5". Weight: 70 oz. Color: Gold. Rating: General Use.

610034 4" Triple, Bushing  
610034B 4" Triple, Bearing

Meets NFPA 1983/ANSI/OSHA strength specifications for Pulleys

GENERAL USE



### Stainless Steel Triple Pulley

Super-Strong and Super-Durable. For rope diameters 3/8" - 5/8". Rigging Hole accommodates 3 large rescue carabiners. Dimensions: 8" x 4.75" Weight: 5.25 lbs. Strength: 30,000 lbs.

6102134 Bushing  
6102135 Bearing

Meets NFPA 1983/ANSI/OSHA strength specifications for Pulleys

RESCUE TECH

www.rescuetechn1.com



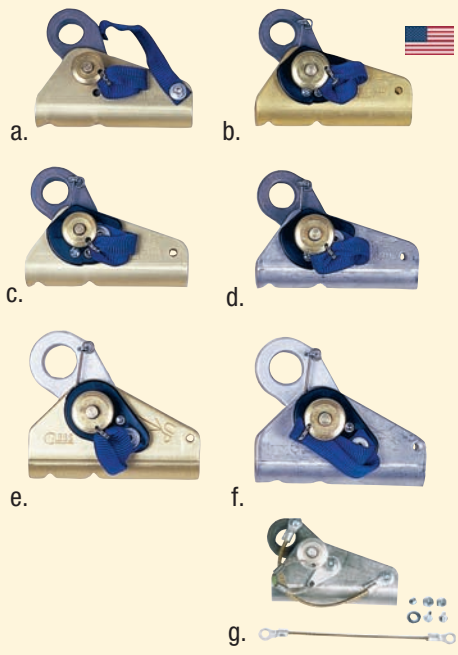

## Gibbs Ascender New Spring Design

One of the strongest closed cam type of rope-grab ascenders. Rounded tooth cam design minimizes rope wear yet holds on wet or icy ropes. New spring attachment increases cam's range of motion to decrease chance of spring breakage. 1/2" model attaches to synthetic ropes 5/16" to 1/2"; 3/4" version accommodates synthetic ropes from 5/8" to 3/4". The spring-loaded type is always in locked position and is recommended for general rescue use. For use on kernmantle rope only.

	Size/Shell/Description	Cam Type	Strength (lbf.)	Weight (oz.)	Rating
a.	602011 1/2" Aluminum, Free Running	Forged	2,500	7	Light
b.	602012 1/2" Aluminum, Spring Loaded	Forged	2,500	7	Light
c.	602012F 1/2" Aluminum, Spring Loaded	Forged	5,200	9.2	General
d.	602112 1/2" Stainless Steel, Spring Loaded	Forged	5,200	12	General
e.	602013 3/4" Aluminum, Spring Loaded	Forged	5,200	14	General
f.	602113 3/4" Stainless Steel, Spring Loaded	Forged	5,200	20	General
g.	602201 Replacement Spring Kit (Ascender not included)				

Meets NFPA 1983 strength specifications for ascenders.

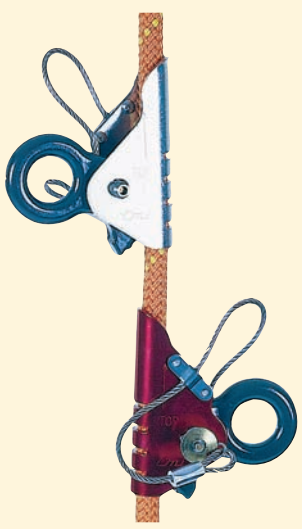

Top: Stainless Steel; Bottom: Aluminum

## GMI Ropewalker Ascender

Manufactured from alloy aluminum or stainless steel and forged aluminum cam. Large attachment point accommodates multiple carabiners. Unique spring design allows for easy adjustment of tension. Spring tested to over 1 million cycles. 3/8" to 5/8" diameter rope capacity. Pin can be inserted from either left or right side to accommodate needs of rescuer. 3 sigma rated to 7,700 lbf. Rating: General Use. For use on kernmantle rope only.

602241	Aluminum
602245	Stainless Steel

Meets NFPA 1983 strength specifications for ascenders.



## Gibbs Slinger™

We combine the rescue versions of the 1/2" Gibbs Ascender with our high strength 1" Flat web to create a versatile rope grab system that virtually eliminates torsion loads on the rope grab and carabiner.

602212A	Aluminum
602212S	Stainless Steel

Meets NFPA 1983 strength specifications for ascenders.



## ISC Rescue Ascender New Pin Design

Manufactured from high strength aluminum alloy. Machined from thick walled extrusion for extra durability. Shell has special curved rope interface section for superior rope strength and minimized rope damage. Rigging point will accommodate all of our carabiners and will pass many locking collars. Quick-attach pin for easy attachment. For use on kernmantle rope only.

602251	Standard, 7/16-1/2"
602252	Large, 5/8"

Meets NFPA 1983 strength specifications for ascenders. BS EN 567 Certified as Rope Clamps

**⚠ WARNING**

**SHOCK LOADING**

Ascenders: Standard cam-type ascenders can severely damage or destroy a rope if subjected to extreme shock loading. Use caution when using systems incorporating standard cam ascenders.



GENERAL  
USE



Top: Ultrascender (Black)  
Bottom: Ultrascender (Red)

## Ultrascender

One of the strongest open-sided ascenders available. Machined from solid aircraft aluminum extrusion with 4140 chrome-moly steel cam with a new non-metallic finish that has the same corrosion resistance as stainless steel and is harder than knife blades and files. The unit will accommodate ropes from 1/4" (6mm) to 5/8" (16mm) in diameter. Special safety gate design is superior to other open-sided ascenders. Attach to carabiners, ascender slings, or combination. Set includes one right and one left hand unit. Tensile Strength: 5,000 lbf. Rating: General Use. Dimensions: 7.5 x 9" ea. Wgt/pair: 18 oz.

- |          |                         |
|----------|-------------------------|
| 6020031N | Ultrascender, Pair (BK) |
| 6020034N | Ultrascender, Pair (RD) |

Meets NFPA 1983 strength specifications for ascenders.



## GIBBS KlimAir

A new item from the makers of the Classic Gibbs Ascender, the Klimair acts as a mechanical prusik knot. Its bi-directional rope grabbing capability allows a multitude of uses. The swivelling rigging point lets this unit work with positioning ropes and permits the climber to climb past obstructions (girders, tree limbs, etc.) without removing the unit or utilizing a second rope grab. For use on 1/2" synthetic ropes only. Secures to rope with a split ring and clevis pin.

- |        |               |
|--------|---------------|
| 602263 | Gibbs Klimair |
|--------|---------------|

## Industrial Rope Grab with Lanyard For Vertical Lifelines

Stainless steel fall arrest device especially designed for vertical applications. Unlike other cam-type grabs, these grabs slip before rope failure. Rope Grab clutching effect begins at 1,000 lbf. on 1/2" ropes. For this reason use ONLY on the correct diameter rope. These grabs have the 2" diameter rigging hole to prevent rollout of attaching snaps. Comes with a permanently attached nylon lanyard equipped with a double locking snap hook. Manufactured in the U.S.A. Weight: 1.5 lbs.

- |         |                                  |
|---------|----------------------------------|
| 6025231 | 7/16" Rope Grab with Web Lanyard |
| 6025241 | 1/2" Rope Grab with Web Lanyard  |
| 6025251 | 5/8" Rope Grab with Web Lanyard  |

Meets all OSHA, NFPA, CSA, and ANSI standards for rope grabs and ascenders.



GENERAL  
USE

## Anthron Handled Ascender

A great new handled ascender.



Manufactured of aluminum, the Anthron fits ropes 8mm - 1/2" in diameter. Special grip material on handle is very comfortable and is slip-resistant. Fits ropes 8mm - 1/2".



GENERAL  
USE

- |            |             |            |
|------------|-------------|------------|
| Weight:    | 8.5 oz.     | 204 gm     |
| Dimensions | 7.6" x 3.6" | 194 x 93mm |

- |        |                   |
|--------|-------------------|
| 602301 | Left Hand (Gold)  |
| 602302 | Right Hand (Blue) |

Meets NFPA 1983 strength specifications for ascenders.

## Anthron Chest Ascender

Chest Ascender for Rope Access

Manufactured of aluminum, the Anthron fits ropes 8mm - 1/2" in diameter. Works with New VANGUARD™ and Observer™. Fits ropes 8mm - 1/2". Color:



- |            |                  |
|------------|------------------|
| Weight:    | 4.9 oz.          |
| Dimensions | 4.6 x 2.9 x 1.4" |

- |        |                |
|--------|----------------|
| 602306 | Chest Ascender |
|--------|----------------|

Meets NFPA 1983 strength specifications for ascenders.



GENERAL  
USE





## Petzl I'D® NFA

*For Descending and for Belaying, with an Anti-Panic function.*

Swinging side plate with safety catch decreases risk of dropping device and allows rapid installation of the rope into the device. Anti-error feature helps avoid accidents due to incorrect installation of the rope in the device. Self-braking system: if the handle is released during descent, the cam rotates to pinch the rope and brake the user's descent. Anti-panic handle: the I'D® will lock onto the rope if the user pulls too hard on the handle. To descend, simply pull on the handle; the rate of descent is controlled by varying the grip on the free end of the rope with the other hand. For work positioning, the handle can be rotated to secure the I'D® in place on the rope, thus eliminating the need to "tie off" the device. May be used as a progress capture device in a haul system; allows rapid conversion between raising and lowering. Individually tested. Weight: 18.7 oz.

- 2354120N Large - NFPA G, 11.5-13 mm
- 2354120S Small - NFPA L, 10 - 11.5 mm

CE EN 341 class A, Large: NFPA G. Small: NFPA L.

## Pro-Traxion Ratchet Pulley

For effective and comfortable hauling of heavy loads. Very effective as a progress capture device for travel along a Tyrolean traverse.

- 38mm sheave mounted on sealed ball bearings for high efficiency.
- Moving sideplate allows the rope to be installed when the device is attached to the anchor.
- Chrome-plated steel cam has inclined teeth and self-cleaning slots to provide grip on wet, icy or muddy ropes.
- For use with ropes from 5/16" - 1/2"
- Strength, Pulley only: 22 kN.
- WLL, Pulley only: 6 kN.
- Strength - Ratchet Pulley: 4 kN.
- WLL - Ratchet Pulley: 2.5 kN.



23541651 Pro-Traxion

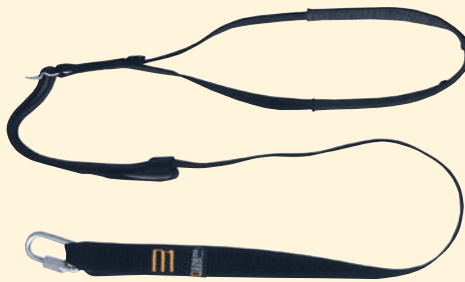

## Adjustable Foot Sling

A handy sling that, when used with a handled ascender, allow the rescuer to climb up a rope. Easily attaches to ascender with rapid link (link not included). Adjustable length.

602431 Adjustable Foot Sling  
60510106 Connector



## Ascender Sling Set

Designed for use with handled ascenders to allow rescuer to climb back up a rope. Manufactured of high quality 1" nylon webbing (Tensile Strength: 6,000 lbf.). One sling attaches to a seat harness, the stirrup connects a second ascender to the right or left foot. Weight: 8 oz./pair. Color: Orange.

602300 Medium - up to 6' height  
602400 Large - over 6' height

**⚠ WARNING**

Technical rescue and safety is potentially hazardous. Any person using equipment sold by RESCUE TECHNOLOGY in any manner is personally responsible for learning the proper techniques involved, and assumes all risks and accepts full and complete responsibility for any and all damages or injury of any kind, including death, which may result from the use of any RESCUE TECHNOLOGY equipment.

## Double Foot Sling

For those time where a single foot loop will not work, the RescueTECH Double Foot Sling fits the need. A handy sling that, when used with a handled ascender, allows the rescuer to climb up a rope. Easily attaches to ascender with rapid link or girth hitch. Foot loops held open by special stiffener.



024321 Double Foot Sling



## Deluxe Ascender Sling Set

Can be configured for both Texas and "Frog" style ascending systems. Simply attach slings via rapid link or girth hitch to ascenders. Adjustable harness attachment slings give this set a wide size range. Manufactured of high quality 1" nylon webbing. Two slings attach to a seat/chest harness. The double foot loops connects a second ascender to the rescuers feet. Special adjuster for the foot loops help prevent loops from sliding off boots.

6024334

*Ascenders, Rapid Links and Carabiners not included*





GENERAL  
USE

### RescueTECH BailOut 8™

A compact 8 with ears for quick personal escapes. Machined from 1/2" alloy aluminum. Rescue "ears" are situated to provide a compact Rescue 8 design for escape systems. Dimensions: 4.5" x 3.75". Strength: 4,946 lbf. WLL: 300 lbs. Weight: 4 oz. Rating: General Use.

601008 BailOut 8™

Meets NFPA 1983/ANSI construction specifications for Descenders.



GENERAL  
USE

### RescueTECH Escape 8

A compact Escape descender with ears for quick personal escapes. Rescue "ears" are situated to provide a compact Rescue 8 design for escape systems. Dimensions: 2 7/8" x 2 3/4". Strength: 3,150 lbf. WLL: 300 lbs. Weight: 4 oz. Rating: Escape Use.

6010064 Red  
6010061 Black

Meets NFPA 1983/ANSI construction specifications for Descenders.



RT Escape Descender shown in one of many friction settings.

### Escape Descender

Special descender plate with multiple holes that allow a small diameter escape cord to be rigged to accommodate different amounts of friction. ALWAYS test your personal rigging method to assure sufficient friction for a safe descent. Works with 8mm to 11mm diameter escape lines. Dimensions: 4" x 2.75". Tensile Strength: 5,000 lbf. Rating: General Use.

601005 Escape Descender

Meets NFPA 1983/ANSI construction specifications for Descenders.

### Tuba® Belay Tube

Designed for lowering loads over long distances. The braking power is easily adjusted by varying the number of turns of rope around the device. Special shape allows the passage of a knot, allowing several ropes to be joined together for long lowers. Weight: 43.7 oz. NFPA G.

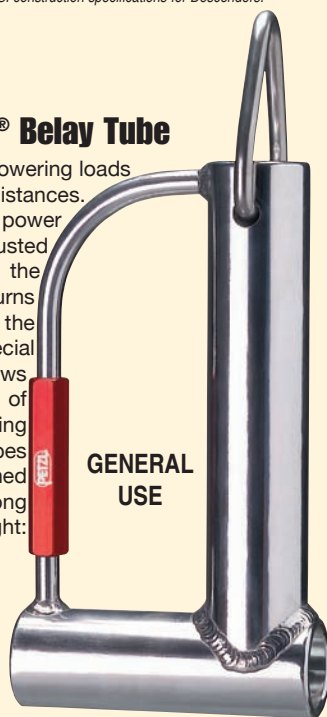

GENERAL  
USE

2354212 Tuba

Meets NFPA 1983/ANSI construction specifications for Descenders.



### Anthon Double Stop Descender

A manually operated controlled descent device that utilizes a cam assembly that provides friction on the rope to hold a load, or allow the load to descend. To begin descent, the user depresses the control lever. If the control lever is fully depressed in a panic situation, the descent will stop. Normally, connected directly to the users seat harness, the Anthon may be attached to a rigging point and used as a lowering device. Can be placed on the rope at any point. WLL: 300 lbs. For 3/8" - 7/16" ropes. Best control with 7/16" ropes. Dimensions: 7.5 x 3.3". Weight: 8 oz.

6010097 Anthon Descender, 7/16"

Meets NFPA 1983/ANSI construction specifications for Descenders.



### ISC SARAB Descender Superior Control vs. Competition

Special descender with a 500 lb. Working Load Limit. Complete with a double action anti-panic handle. Manufactured from aluminum alloy. 100% inspected and function tested. Works on rope diameters: 10.5 - 11.5mm. ALWAYS test your personal rigging method to assure sufficient friction for a safe descent. Tensile Strength: 5,000 lbf. Dimensions: 193 x 79 x 35mm Rating: General Use.

601340 ISC Descender

Meets NFPA 1983/ANSI construction specifications for Descenders.

## WARNING

Technical rescue and safety is potentially hazardous. Any person using equipment sold by RESCUE TECHNOLOGY in any manner is personally responsible for learning the proper techniques involved, and assumes all risks and accepts full and complete responsibility for any and all damages or injury of any kind, including death, which may result from the use of any RESCUE TECHNOLOGY equipment.



GENERAL  
USE

**RescueTECH™  
Steel Rescue 8**  
*Three Dimensional Design*

Forged Steel Rescue 8 Descender. For ropes up to 3/4" diameter. Three dimensional design allows user to vary friction depending on which way the descender is used. Drop forged. Chromium Plated Silver. Tensile Strength: 15,000 lbf. WLL: 1500 lbs. Dimensions: 6.75" x 6.75". Weight: 24 oz. Rating: General Use.

- 6010070 Silver
- 6010071 Black - **NEW!**

Meets NFPA 1983/ANSI construction specifications for Descenders.



GENERAL  
USE

**Rescue TECH Figure 8**  
*Traditional Design*

The RescueTECH Figure 8 is an economical anodized figure 8 descender for light duty use. Forged aluminum construction. Rappel/Belay Usage Strength: 7000 lbf. WLL: 700 lbs. Dimensions: 5 1/2" x 2 7/8". Weight: 4.8 oz. Rating: General Use.

- 601316 Figure 8 (Blue)
- 601311 Figure 8 (Black)

Meets NFPA 1983/ANSI construction specifications for Descenders.



GENERAL  
USE



**CMI Rescue / Regular 8 Descenders**  
*The Original Rescue 8*

Cold forged design with durable hard-coat anodized finish. Rescue 8 has "ears" to aid in "locking-off." Color: Charcoal. Rating: General Use. Dimensions: Large: 6.6" x 6"; Small: 5.5" x 2.73".

		Dim. (in.)	Weight (oz.)	Strength (lbf.)	WLL (lbs.)	NFPA Rating
601000N	Rescue 8	6 3/4 x 6 1/8	7.8	10,000	1000	General
601001N	Regular 8	5 1/2 x 3	4.2	10,000	1000	General

Meets NFPA 1983/ANSI construction specifications for Descenders.



GENERAL  
USE

**Stainless Steel  
Small Rescue 8**

A small rescue 8 with the durability and strength of Stainless Steel. Strength: 9000 lbf. Only 5.7" long, this tough unit will fit into almost all rescue kits. Dimensions: 5.7" x 5.3". Weight: 16 oz.

240180510



Descender Link shown with BailOut 8 (not included)



**Descender Link**

A multiple loop extension for descenders. Built with the same high strength design as our daisy chains, the directional loops allow multiple adjustments of the overall length of the descender system.

758124 Descender Link

**CAUTION:** Care must be taken when using the Steel Rescue 8 to rappel, belay, or lower personnel or heavy loads. Steel does not provide as much friction as aluminum figure 8's of similar design and size.

**▲ WARNING**  
Technical rescue and safety is potentially hazardous. Any person using equipment sold by RESCUE TECHNOLOGY in any manner is personally responsible for learning the proper techniques involved, and assumes all risks and accepts full and complete responsibility for any and all damages or injury of any kind, including death, which may result from the use of any RESCUE TECHNOLOGY equipment.

LIGHT  
USE

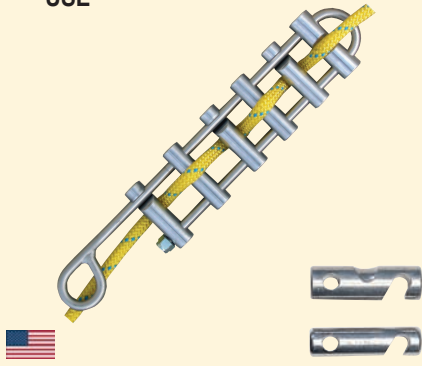

### RescueTECH Rappel Rack

This is the classic design developed in the 1960's. Primarily designed as a personal rappel device on a single rope 3/8" to 1/2" in diameter. Top Bar and Top Bar - Hyperbar has a training groove on one side to assist in guiding the rope and aid in proper rigging.

601024W	Standard, Complete
601011	Replacement - Grooved
601010	Replacement - Angle Slot
601011H	Replacement - Hyperbar

Meets NFPA 1983/ANSI construction specifications for Descenders.

GENERAL  
USE

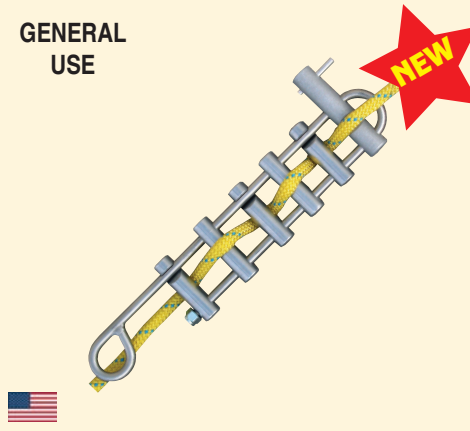

### RescueTECH Rescue Rappel Rack

This is an upgraded version of our popular rappel rack. Large bars provide greater strength and control of rescue loads. Top Hyperbar aids in lock-offs. Grooved bars help guide the rope through the rack.

601124 Rescue Rappel Rack

Meets NFPA 1983/ANSI construction specifications for Descenders.

### ▲ WARNING

Technical rescue and safety is potentially hazardous. Any person using equipment sold by RESCUE TECHNOLOGY in any manner is personally responsible for learning the proper techniques involved, and assumes all risks and accepts full and complete responsibility for any and all damages or injury of any kind, including death, which may result from the use of any RESCUE TECHNOLOGY equipment.

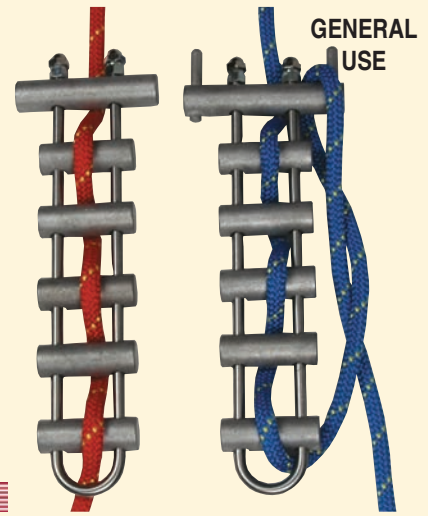

### RescueTECH Rescue Rack™ Superior Control of Rescue Loads

The safest, heavy duty lowering and rappelling device. Can be placed onto rope at any point. Friction may be varied by sliding easily rigged bars up or down — even while on rappel or during lowering operations. Specially designed straight cut 1" aluminum friction bars help prevent mis-rigging. Extended top bar for quick lock-off. Accommodates ropes from 1/4" to 1 1/2" or double ropes up to 3/4". One person can easily control a 1,000 lb. load. Frame manufactured of 304 stainless steel and will accommodate four 13mm carabiners. Special design of the frame distributes the load between both sides of the unit. Tensile Strength: 10,000 lbf. WLL: 1,000 lbs. Dimensions: 15" x 3". Weight: 30 oz.

601102	Standard (shown left)
601202	Hyperbar (shown right)

Meets NFPA 1983/ANSI specifications for Descenders.

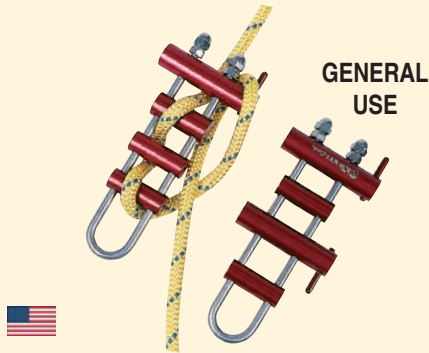

### CMI Mini Rescue Rack

A handy alternative for shorter drops and lighter loads. Similar in design to the standard CMI Rescue Rack by uses 5/16" Stainless Steel for the frame and aluminum for the brake bars. Top bar is oversized with a single lock-off pin. Pre-assembled with two fixed and two straight slotted bars. Weight: 11 oz. Dimensions: 8.25" x 3.5". Strength: 14,000 lbf. Rating: General Use.

601112	Standard HyperBar
601113	Double HyperBar

Meets NFPA 1983/ANSI specifications for Descenders.

GENERAL  
USE

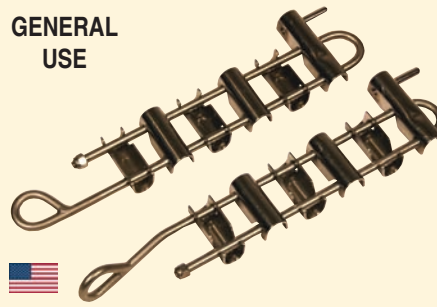

### CMI NFPA Rappel Rack With Hyperbar

Welded eye construction available in parallel or 90° to the bars. All welds are Zyglu inspected to insure reliability. The rack comes pre-rigged with six angle slotted Stainless Steel bars. Length: 19 1/2". Weight: 15.2 oz.

601034N	Standard
6010349N	90° Rigging Point

Meets NFPA 1983/ANSI specifications for Descenders.

**CAUTION:** Care must be taken when using the Steel Brake Bars to rappel, belay, or lower personnel or heavy loads. Steel does not provide as much friction as aluminum.

GENERAL  
USE

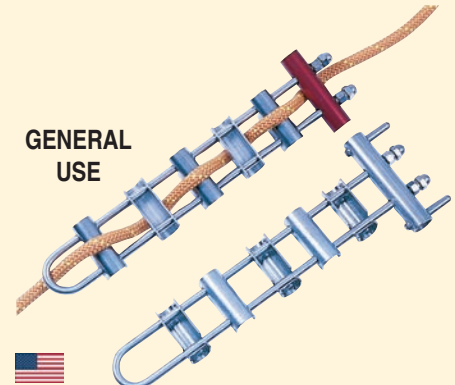

### CMI Rescue Rack Oversized Aluminum Top Bar and Stainless Steel Friction Bars

3/8" diameter stainless steel frame fitted with oversized aluminum top bar and 5 stainless steel brake bars. To compensate for the reduced friction inherent in stainless steel bar, the diameter of the friction surface is a full 1". The special "open back" design of the bars help avoid improper rigging. Hyperbar model features stainless steel top bar with two lock-off pins. Length: 16" Strength: 19,000 lbf.

601102S	Standard (shown top)	Weight	34 oz.
601115S	HyperBar		35 oz.

Meets NFPA 1983/ANSI specifications for Descenders.

RESCUE TECH

www.rescuetechn1.com



**GENERAL USE**



**Magnum Rigging Plate**

Large size and 16 holes to accommodate multiple rigging needs. Manufactured of alloy aluminum. Rating: General Use.

Length:	9.75"	249 mm
Width:	5.875"	150mm
Hole size:	3/4"	19 mm
Weight:	17 oz.	471 gm
Strength:	12,365 lbf.	55 kN
WLL:	1,236 lbs.	561 kg

603216 Magnum Rigging Plate

**GENERAL USE**



**Technical Rescue Rigging Plate**

A standard size multi-hole rigging plate. Manufactured of alloy aluminum. Rating: General Use.

Length:	6.62"	165.6 mm
Width:	4.32"	108 mm
Hole size:	3/4"	19 mm
Weight:	9.4 oz.	262 gm
Strength:	12,365 lbf.	55 kN
WLL:	1,236 lbs.	561 kg

603215 Technical Rigging Plate

**GENERAL USE**



**Stainless Steel Rigging Plate**

*Heavy Duty / Lightweight*

Designed to compliment your existing rigging equipment. Lightweight, strong and effective. Allows rigging team to set up more efficient anchor systems. Prevents carabiners from jamming together. Machined from stainless steel. Dimensions: 5" x 5". Weight: 8.6 oz. Strength: 13,000 lbf. WLL: 1300 lbs. Rating: General Use.

603211 Stainless Steel



**GENERAL USE**

**Beam Clamp**

Designed as a high strength portable rigging point for both horizontal and vertical I-Beam structures. The turnbuckle type threaded mechanism allows quick attachment to 3" - 9" flange widths. Every unit is tested and certified before shipment.

	<b>Standard Duty</b>	<b>Heavy Duty</b>
WLL, Personnel:	1,000 lbs.	2,000 lbs.
WLL, Equipment:	2,000 lbs.	4,000 lbs.
Weight:	10 lbs.	11 lbs.
Rating:	General	General

603411 Standard  
603412 Heavy Duty

**GENERAL USE**



**Rigging Rings**

Traditional forged rings to be used as rigging rings, connection points for rigging a stretcher, and many other uses. Drop forged alloy steel. Inside Diameter: 3 inches. Rating: General Use.

	<b>Description</b>	<b>Strength (lbf.)</b>	<b>Wgt (oz.)</b>
603230	1/2" Ring	10,000	9.7
603240	9/16" Ring	44,000	12.5



**Micro Rigging Plate**

The smallest rigging plate in the Rescue Technology line. Made from 1/4" alloy aluminum plate, the Micro Rigging Plate is both strong and lightweight. Ideal for Search and Rescue, Climbing, and Litter Bridles. Dimensions: 3.5" x 3.25". Hole size: 13/16". Strength: 35kN (7,800 lbf.)

603214 Micro Rigging Plate

**▲ WARNING**

Technical rescue and safety is potentially hazardous. Any person using equipment sold by RESCUE TECHNOLOGY in any manner is personally responsible for learning the proper techniques involved, and assumes all risks and accepts full and complete responsibility for any and all damages or injury of any kind, including death, which may result from the use of any RESCUE TECHNOLOGY equipment.



## Remote Retrieval Hook

### Hold-Tite Pole Adapter Holds Hook

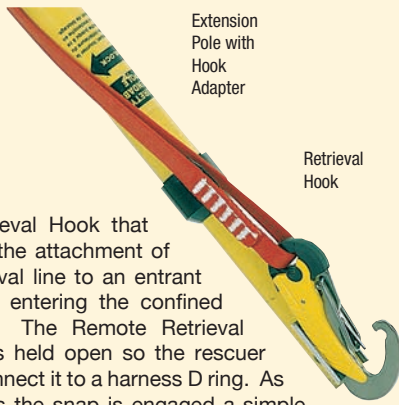

Extension Pole with Hook Adapter

Retrieval Hook

A Retrieval Hook that allows the attachment of a retrieval line to an entrant without entering the confined space. The Remote Retrieval Hook is held open so the rescuer can connect it to a harness D ring. As soon as the snap is engaged a simple tug will lock the Hook to the harness. Sling may be attached to end of retrieval line for victim rescue. Comes complete with auto-locking snap and nylon sling. Extension Pole with Hook Adapter sold separately. Hook Materials: Stainless Steel w/ protective plastic shroud. Gate Opening: .75" Hook Strength: 5,000 lbs. Remote Retrieval Hook and Pole sold separately

616101	Retrieval Hook w/ Sling
616112	Extension Pole, 6 - 12 ft.
616124	Extension Pole, 8 - 24 ft.
616200	Storage Bag, 6 - 12' Pole
616210	Storage Bag, 8 - 24' Pole



## Forged Anchorage Connector I

### With Threaded Stud

Drop forged alloy steel. Meets or exceeds ANSI Z359.1 and CSA Z259.12-00. Complete with grade 9 nut and lock washer. Recommended torque value: 45 - 55 ft-lbs. Bolt diameter: 1/2"

603105 Anchor Connector I 29.00



## Forged Anchorage Connector II

### For 1/2" or 5/8" Bolts

Drop forged alloy steel. Meets or exceeds ANSI Z359.1 and CSA Z259.12-00. Use minimum grade 8 bolt and nut with lock washer. Select 1/2" or 5/8" bolt models. Bolt Length: 1.5". Recommended Torque Values: 1/2" 13 TPI bolt: 65 - 75 lbs.; 5/8" 11 TPI Bolt: 145 - 155 ft-lbs.

603108 For 1/2" x 13 TPI Bolt  
603109 For 5/8" x 11 TPI Bolt



## CMI Drag Hook

Manufactured of forged steel eyebolt and five 4140 chromemoly steel tines. Each tine is heat treated to resist a load of approximately 2,000 lbf. Each Drag Hook is sandblasted and coated with baked-on epoxy coating. Available Deployment Bag is specifically designed for use with the Drag Hook. Dimensions: 12" x 8.5". Weight: 3 lbs. Color: Black.

624100	Drag Hook
624105	Deployment Bag



## ISC Girder Grip

### For Steel Work

Anchor designed to provide secure anchor points through steel structure. Fits hole size: 19 - 28mm. Manufactured of high tensile strength steel and aluminum. Minimum strength: 6,000 lbf.

603110 Girder Grip

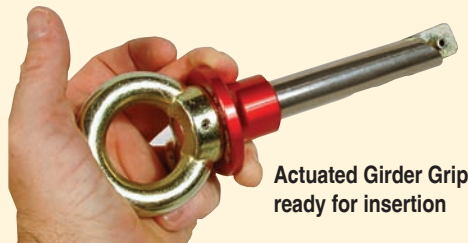

Actuated Girder Grip ready for insertion



## Snow/Sand Picket

Custom "Anchor" shaped structural aluminum alloy pickets in two lengths. Multiple rigging holes for ease of use. No sharp edges. Powder coated for durable good looks.

603136 36" Picket

## ▲ WARNING

Technical rescue and safety is potentially hazardous. Any person using equipment sold by RESCUE TECHNOLOGY in any manner is personally responsible for learning the proper techniques involved, and assumes all risks and accepts full and complete responsibility for any and all damages or injury of any kind, including death, which may result from the use of any RESCUE TECHNOLOGY equipment.



## 2:1 Pick Off Strap

### Built-in Mechanical Advantage

Used for patient pick-off situations. Configuration allows for 2:1 and 3:1 mechanical advantage for easier handling of loads. Materials: 1 3/4" Heavy Duty TECHWeb webbing with Forged D-Ring and Adjuster Buckles. Strength: 7,000 lbf.

756104 2:1 Pickoff Strap



## Transfer Sling

### Ideal for Rescue Pick-Off

Manufactured with heavy duty TECHWeb 1 3/4" flat webbing and has a forged "D" ring sewn in one end and an adjustable "V" ring on the other end. Adjusts by pulling on the hand loop. The "V" ring adjuster buckle slips at 4,500 lbf. Hardware Proof Load: 2,500 lbf. Weight: 12 oz. Length: 10 - 54" Rating: General Use.

756103 Transfer Sling



## Adjustable Rigging Sling

### With Heavy Duty TECHWeb

An adjustable length rigging sling. Manufactured of heavy duty TECHWeb 1 3/4" flat webbing and has a forged "D" ring at each end. Adjusts with a slide adjuster. Webbing Strength: 10,000 lbf. Tensile Strength: 8,000 lbf. WLL: 800 lbs. Length: Adjustable 5 - 9 ft. Weight: 10 oz. Color: Gold.

756106 Adjustable, 2- 6 ft.  
756105 Adjustable, 5- 9 ft.

## Heavy Duty Load Release Strap

The Load Release Strap uses 10,000 lbf. rigging "D" Rings and a standard 1.75" forged "D" on the adjustment part. 10,000 lbf TECHWeb is used to provide superior strength over units using type 13 webbing. Designed to prevent the adjustment end of the webbing from sliding through the rigging "D" rings.

756202



## Eye Sling™

### Unique Loop Sling with Rigging Eye

Specially constructed loop sling with a rigging eye at one end. Strength: 6745 lbf. WLL: 675 lbs.

2389201 24"  
2389203 48"  
2389204 60"

Meets CE, EN 354, ED 795B

## TECHNote™

### Sling and Lanyard labeling

Rescue Technology labels all of our Rescue Slings and Lanyards with recommended Working Load Limits. Where applicable, the WLL is illustrated for a variety of rigging uses. Since the label states specific limits, rescuers don't have to calculate load limits during the rescue. For Quality Control purposes, the labeling also specifies part number, Production Lot Number and Production date. This information lets us track all aspects of the production of the equipment.

RESCUE TECHNOLOGY 770-832-9694 FAX (770)832-1676					WARNING: Exceeding Working Load Limit can result in loss of load, serious injury, or death. Do NOT expose to temperatures above 250°F. Do NOT use unless properly trained. INSPECT BEFORE EACH USE!! Meets ANSI/OSHA/NFPA
Maximum Working Load Limit for NEW sling *WARNING* DO NOT EXCEED					
WWL @ 10:1	Vertical	Choker	90° Basket	60° Basket	
	lbs. ■	lbs. ●	lbs. ■	lbs. ▲	
Part No.	Length ft.		Lot	Date	



**Heavy Duty  
Anchor Sling**  
*Strongest 1" Heavy Duty  
Double End Rigging Sling*

Eliminates wasted rigging time spent tying knots in rigging lines. Made from 1" solid weave, high strength nylon webbing. The special webbing has RED tracers to indicate cuts in the webbing. Available in multiple lengths, each sling has a sewn loop at each end to provide maximum versatility. Anchor points may be wrapped single, double, triple, etc., to suit particular rescue situations. Anchor Slings exceed all standards and regulations for Light Use Life Support lines. When looped like a basket hitch, anchor slings meet General Use load requirements. Tensile Strength: 8,500 lbf. WLL: 850 lbs. Color: Yellow.

7550032	3 ft.
7550042	4 ft.
7550052	5 ft.
7550062	6 ft.
7550082	8 ft.
7550102	10 ft.

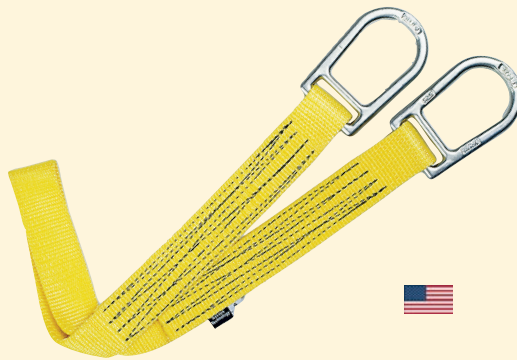

**Super Duty Anchor Sling**  
*Strongest Webbing Slings in the Rescue  
Industry*

Manufactured from 2" wide solid weave high strength webbing. Special RED internal tracers function as edge cut indicators that are exposed when the webbing edge is abraded, cut, or torn. Large heavy duty forged steel links on each end will allow end-to-end, basket, and choker use of the sling. Exceed all standards for two person lifeline strengths. Tensile Strength: 15,000 lbf. WLL: 1,500 lbs. Color: Yellow. Rating: General Use.

756504	4 ft.
756506	6 ft.
756508	8 ft.
756510	10 ft.



**Heavy Duty  
Anchor Sling w/ "D" Ring**  
*Made with TECHWeb*

Manufactured from heavy duty TECHWeb flat webbing (Tensile Strength: 10,000 lbf.). Each sling has a "D" ring (proof Load: 5,000 lbf.) sewn at each end to provide maximum versatility. Anchor points may be wrapped single, double, triple, and rigged choker-style to suit particular rescue situations. When looped like a basket hitch, anchor slings meet General Use load requirements. Although webbing tensile strength is high, overall tensile strength is limited by the "D" rings. Tensile Strength: 8,000 lbf. WLL: 800 lbs. Color: Yellow.

7591032	3 ft.
7591042	4 ft.
7591052	5 ft.
7591062	6 ft.
7591082	8 ft.
7591102	10 ft.
7591152	15 ft.

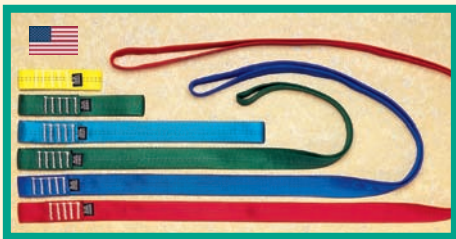

**Standard Rescue Loop**  
*High Strength Continuous Loop*

High strength 1" Tubular Webbing (4,500 lbf.) provides a high strength loop. Because of the high strength and abrasion resistance of the Rescue-Spec™ Tubular webbing RescueTECH Standard Rescue Loops will outlast conventional tubular webbing slings. Strength: 7,400 lbf. WLL: 740 lbs. Colors: Assorted.

7612012	12 in.
7612024	24 in.
7612036	36 in.
7612048	48 in.
7612060	60 in.



**Heavy Duty  
Anchor Loop**  
*Heavy Duty Continuous Loop*

Constructed of same heavy duty webbing as the Anchor Sling. This unit is sewn to form a continuous high strength rigging loop. Items are sold by linear measurement of the loop laid flat. Anchor Loops meet all standards and regulations for two-person life support lines. Tensile Strength: 13,000 lbf. WLL: 1,300 lbs. Color: Yellow. Rating: General Use.

7540042	4 ft.
7540062	6 ft.
7540082	8 ft.
7540102	10 ft.



**Steel Cable Sling**

The highest quality life support slings made from flexible 3/8" steel cable. Manufactured with Flemish eye splices with steel swages per OSHA/ANSI standards. Each unit is tagged with date of manufacture, size, and working load in tons. Steel slings are excellent in areas of extreme high/low temperatures, chemical exposure, and abrasion. Proof Tested: 5,400 lbf. WLL: 2,700 lbf. Rating: General Use.

759304	4 ft.
759306	6 ft.
759310	10 ft.
759315	15 ft.



## RescueTECH Webbing

RescueTECH Rescue-Spec Tubular webbing is specially designed for the demands of rescue by exceeding the strength specifications of normal mil-spec webbing. Additionally, it will outwear any comparably sized tubular webbing. Special Lock-Stitch is used to make RescueTECH tubular webbing superior all other tubular webbings - even mil-spec.

For heavy duty rigging conditions, we recommend the use of our Rescue Technology Heavy Duty Flat Webbing. The Heavy Duty Webbing is more abrasion resistant than standard 1" tubular.



**RESCUE TECH**

TUBULAR		ft.	50 ft.	150 ft.	300 ft.
7900	9/16"	X			X
7901	1"	X	X		X
7902	2"	X		X	
FLAT		ft.	50 ft.	150 ft.	300 ft.
7945	1"	X	X	X	
7921	1 3/4"	X		X	
7932	2"	X		X	

Width	Style / Type	Strength	Colors Available
9/16"	Rescue-Spec Tubular	2,299 lbf.	Black, Red, Royal Blue, Teal
1"	Rescue-Spec Tubular	4,200 lbf.	Black, Blue, Green, Orange, Red, Yellow, Purple, Tan
2"	Rescue-Spec Tubular	6,800 lbf.	Black, Blue, Red, Yellow
Width	Style / Type	Strength	Colors Available
1"	Heavy Duty Flat	6,000 lbf.	Black, Blue, Green, Orange, Red, Yellow
1 3/4"	Heavy Duty Flat	6,000 lbf.	Black
2"	Seat Belt Type Flat	6,000 lbf.	Black



### Screamer Load Limiter

Multi-functional energy absorbing device. Exceptionally good for use in anchor point protection in any raising or lowering system. The load limiters not only absorb energy when a system is overloaded but they act as a very reliable rescue system overload indicator. The load limiters can be "ganged" to accommodate various activation forces (550, 950, 1200 lbf.). Activation point is consistently repeatable to +/- 7%. Activation Point: 550 lbs Standard. Weight: 2 oz.

753400 Standard Duty



### Rescue Shock Absorber

This is the highly efficient webbing tear-stitch type shock absorber utilized on our lanyards. The Zorber absorbs energy by means of a controlled destruction. Two layers of webbing are woven together in a proscribed manner. Limits OSHA style loads to a maximum force of 900 lbf. Initial Length: 10", Extended Length: 52". Minimum Tensile Strength: 6,000 lbf.

		Weight
a.	753420 Loop & Loop	9 oz.
b.	753422 Loop & D Ring	11.2 oz.
b.	753424 Loop & Snap	15 oz.
c.	753426 Snap & D Ring	20.9 oz.

Meets all ANSI, OSHA standards and CSA construction requirements.

## TECHNote

**Rescue-Spec Webbing Outperforms Mil-Spec Webbing**



RescueTECH 1" Tubular outlasts other types of 1" Tubular. RescueTECH webbing is stronger (4,300 lbf. vs. 4,000 lbf.), more durable (94% greater abrasion resistance), and exceeds MIL-SPEC 4088, Class 1A.

RescueTECH webbing also has greater strength in knots than mil-spec webbing. Strength tests show that RescueTECH webbing tested at over 7,000 lbf. in a loop joined with a "water knot". Mil-spec webbing tested at just over 5,400 lbf.

**www.rescuetechn1.com**



## RT Daisy Chain Strong Rigging Loops

Traditional multiple loop rigging sling with "directional" rigging loops for higher strength. Made from 1" Tubular Webbing. Loop strength of 1,500 lbf exceeds that of competing multi-loop straps. Ultimate Strength: 6,800 lbs. Specify Color: 36" Black or Red (9 pockets); 60" Black or Blue (17 pockets).

7581361	Medium, 36" (BK)
7581364	Medium, 36" (RD)
7581601	Large, 60" (BK)
7581606	Large, 60" (BL)



## Deluxe Webbing Ladder Multi-Unit Connectability

The Deluxe Webbing Ladder offers the features of our traditional 1" Webbing Ladder plus the ability to connect multiple units together. Built in spreader and individual semi-rigid stays keeps the steps open without causing "foot pinching". Multiple ladders may be linked together. 16 steps.

WLL-Step:	300 lbs.
WLL-Unit:	600 lbs.

758625 15 ft.

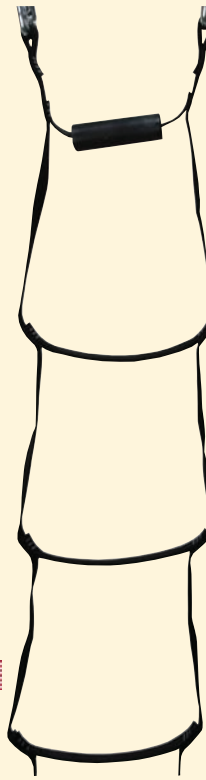

## Webbing Ladder

The Webbing Ladder offers the simplicity of a traditional 1" etrier with increased comfort. Built in spreader and individual stays in the steps insures that steps remain open without causing "foot pinching". Built-in wrist loop. 6 steps.

WLL-Step:	300 lbs.
WLL-Unit:	600 lbs.

758621 6 ft.

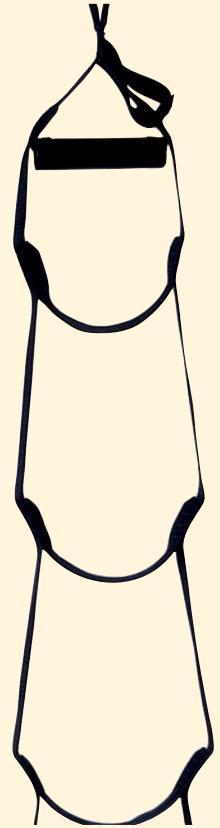

## Multi-Purpose Rescue Strap



15' strap with forged adjuster buckle. Multiple uses: emergency harness, litter strap, rigging sling. Webbing Strength: 6,000 lbf. Buckle Proof Load: 2,500 lbf. WLL: 600 lbs. Weight: 10 oz. Color: Black.

756128 Multi-Purpose Strap

## RT Rescue Etrier

A great help in rescue. Can be used as a simple step-up or at the breakover by safety personnel. Constructed of 1" flat webbing with a protective sheath at the carabiner rigging point for extra abrasion resistance. Double thickness of webbing keep steps open and hand loop at top. Tensile Strength: 5,000 lbf.



758341	4 Step, Black
758342	4 Step, Yellow
758345	4 Step, Green

758361	6 Step, Black
758364	6 Step, Red
758366	6 Step, Blue

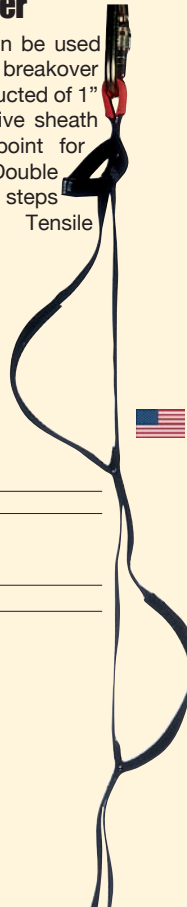

## RT Deluxe Rescue Etrier With Attached Rigging Sling

A modified version of our popular 4 Step Rescue Etrier. We have attached a 24" length of versatile RT Daisy Chain Webbing. Tensile Strength: 5,000 lbf.



758542	Yellow
758545	Green

## ▲ WARNING

Technical rescue and safety is potentially hazardous. Any person using equipment sold by RESCUE TECHNOLOGY in any manner is personally responsible for learning the proper techniques involved, and assumes all risks and accepts full and complete responsibility for any and all damages or injury of any kind, including death, which may result from the use of any RESCUE TECHNOLOGY equipment.



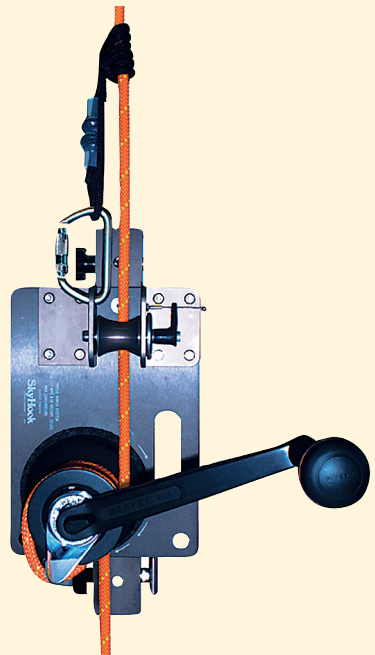

### SkyHook Rescue Winch

The SkyHook system is comprised of an anodized aluminum two-speed self-tailing winch, handle, and mounting system. Will connect to the Sked Evac or Sure-Strong Tripods. Offers ease of raising & hauling loads without the use of bulky block & tackle-style mechanical advantage systems. Best used with 1/2" ropes. Weight 21.5 lbs.

615201 SkyHook Rescue Winch



**▲ WARNING**  
 Technical rescue and safety is potentially hazardous. Any person using equipment sold by RESCUE TECHNOLOGY in any manner is personally responsible for learning the proper techniques involved, and assumes all risks and accepts full and complete responsibility for any and all damages or injury of any kind, including death, which may result from the use of any RESCUE TECHNOLOGY equipment.

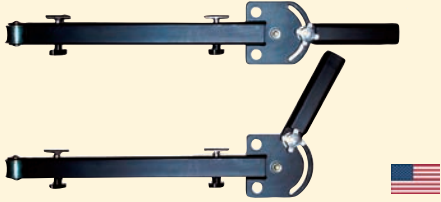

### SkyHook Receiver Hitch Mount

Allows the SkyHook winch to be mounted to a vehicle using a standard receiver hitch. The mount will pivot up to 45° in each horizontal direction to achieve proper rigging alignment.

615202 Receiver Hitch Mount



### SkyHook Power Drive

An electric powered power head turns the winch head. Includes Power Drive, stainless steel drive bit, attachment bracket, and storage box. 110 VAC. Weight: 15.5 lbs. (With case: 21.2)

615210 Skyhook Power Drive



### SkyHook "T" Off-Road Foundation

This attachment gives the winch a large base for ground operations. Weight: 4.8

615204 Ground Stabilizing Mount



### SkyHook Universal Anchor Plate

Provides the winch a stable work platform for anchoring the winch to the ground, telephone poles, etc. Weight: 9.7 lbs.

615205 Universal Anchor Plate



### SkyHook Case

Holds winch and winch drive system as well as Universal Anchor Plate.

615209 Skyhook Case



### Skyhook Web Anchors

The SkyHook Web Anchor Set allows rescuers to quickly attach the Skyhook winch around a column, tree, abutment, etc. Very useful in Industrial and rural applications. Strong ratchet adjusters provide a tight and secure attachment.

615206

## Original Arizona Vortex

### Kit Includes Feet

The Arizona Vortex is a fixed A-frame design with third rotating (easel type) leg. It can be used as a tripod or A-frame. The two-piece legs allow multiple adjustment of upper leg in 6.5" increments. The single section Short Tripod configuration has an inside working clearance of 41". The two-section Standard Tripod has an inside working clearance of 80". With the optional Extra Lower Leg Set, the inside working clearance is 120". The feet are "clawed" with hardened tool steel for excellent holding capability on a variety of surfaces.

Optional Chain Set allows legs to be attached to bolts in floor or rock and prevents legs from spreading. The

Arizona Vortex is packaged in custom designed duffel bags for ease of transport. Weight: 65 lbs.



6198101	Arizona Vortex
6198104	Anchor Chain Set
6198103	Extra Lower Leg Set
2317101	Extra Claw Foot
2317103	Extra Point for Claw Foot
2317105	Extra Flat Foot

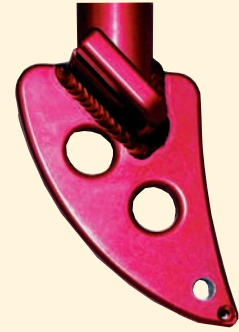

INCLUDED:  
Raptor Claw Foot  
digs into rock  
using tool steel  
point.



Head allows third leg to rotate perpendicular to the other legs



The Original Arizona Vortex includes:

- 1 Head with Carrying Bag
- 3 Upper Legs with Carrying Bag
- 4 Lower Legs with Carrying Bag
- 3 Flat Feet
- 3 Claw Feet with Tips
- 13 Pins with Bag
- 1 Instruction Manual



## Larkin Rescue Frame

An uneven tetrahedron that can replace a tripod or a small rooftop derrick crane for personnel lifting/lowering. The Larkin Frame swivels on its feet and can be set up as a standard tripod or tipped as shown in the photo to reach over an edge or parapet wall. It is especially useful on horizontal tanks with half walkways. The two feet must be secured to prevent slippage away from the breakover when the unit is tipped. Safe Working Load: 600 lbs. Dimensions: 8' x 10'. Weight: 75 lbs. (Shipping Weight: 80 lbs.) Made in Australia. Patented

900200 Larkin Frame





Requires Cable Pulley and Autolocking Carabiner



### Sure-Strong™ Winch

The Sure-Strong™ Winch is used in conjunction with the fall protection system and Sure-Strong Tripod for suspended work positioning, material handling, and as a means of retrieval in an emergency. If the winch is used to lower personnel into a confined space, a backup lifeline must also be attached to the person. The winch comes with a snap-on mounting bracket and attached locking pin. Raises and lowers (minimum 25 lbs.) by simply reversing the cranking direction of the removable handle. Each winch comes with a line weight and double locking swivel hook. Cable: 3/16" galvanized. Rescue Load: 600 lbs.

		Gear Ratio	Weight
6197050	50 ft.	2.85:1	22 lbs.
6197200	200 ft.	3.83:1	54 lbs.

6102118 S. S. Pulley (requires carabiner)  
 60511730 Autolocking Carabiner

61945059 Padded Winch Bag



Sure-Strong Tripod with Optional Winch, Pulley.

GENERAL USE  
 OSHA 2 Person

## Sure-Strong™ Tripod

### High Strength for 2 Person Loads

Lightweight, aluminum, telescoping tripod that meets NFPA, OSHA, ANSI, and CSA strength standards. The unit contains no cast parts and has two anchor points for application flexibility. Special locking mechanism prevents the legs from collapsing while loaded. The included leg security straps increase the tripods full extension strength to an amazing 10,000 lbf. Optional Rigging Bracket provides extra rigging point and allows user to tie-back head of tripod for use as a bipod. The hole alignment of the legs provides for easy set-up and accommodates the snap-on brackets of the Sure-Strong Winch and recovery/retracting lifelines. Baked orange enamel finish.

6191007	7 ft. Heavy Duty
6191010	10 ft. Heavy Duty
6191107	Bag, 7 ft. Tripod
6191110	Bag, 10 ft. Tripod

Meets and exceeds ANSI 359.1-1992  
 Certified by independent engineering firm and CSA.

SPECIFICATIONS	7 ft.	10 ft.
Minimum Static Test Load	11,000 lbf.	11,000 lbf.
Working Load Limit	1,100 lbs.	1,100 lbs.
Rigging Height	7'	10'
Overall Height	7' 6"	11' 1"
Storage Length	61"	102"
Max. Distance between Feet	66.5"	96.5"
Weight	42 lbs.	67 lbs.
Rating, NFPA	General	General
Rating, OSHA	2 Person	2 Person

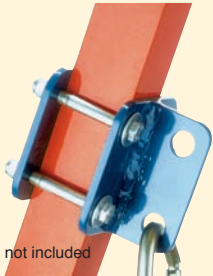

Carabiner & tripod not included

### Leg Rigging Bracket

Special bracket that provides an additional rigging point for safety lines or pulleys. Also designed for use as a tie-back point for stabilizing the tripod when off-center loads are encountered. Alloy aluminum construction. WLL: 600 lbs. Weight: 25.8 oz.

6192107 Leg Rigging Bracket



### Retracting / Recovery '3-Way' Lifeline

For Use with Sure-Strong Tripod

The Retracting/Recovery Lifeline is designed to safely arrest a fall and then, by simply switching to the recovery mode, retrieve the worker. The Retracting/Recovery provides the same benefits and capabilities as the Retracting Lifeline. The Retracting / Recovery "3-Way" lifeline is a fall protection device with a built-in emergency recovery winch. A separate work winch is required for non-emergency lifting. Requires Mounting Bracket to attach to Sure-Strong Tripod leg.

		Weight
618050	50 ft. Cable	34 lbs.
618095	95 ft. Cable	54 lbs.
618050M	Mounting Bracket, 50 ft.	8 lbs.
618095M	Mounting Bracket, 95 ft.	8 lbs.

Meets ANSI Z359.1-1992, CSA Z259.2.



## RescueTECH Technician Tripod

2 Swivelling Rigging points. Spring loaded leg locking mechanisms hold legs in place. Sheaves on head of tripod allow for integration of winches and fall blocks while allowing for increased height under the tripod head. Extruded head and snap out legs for quick and positive deployment. Available with optional load indicating attachment eyes. Manufactured from high strength alloy aluminum and stainless steel fittings.

MBS: 10,000 lbf.  
Working Load Limit: 600 lbs.  
Dimensions:  
Maximum Open Height: 99.6"  
Minimum Open Height: 70"  
Storage Dimensions: 72" x 8.5" x 8.5"  
Weight: 38.5 lbs.

6194101 Tripod  
6194109 Tripod Bag  
  
61945050 Winch, 50 ft.  
61945100 Winch, 100 ft.  
  
61945059 Padded Winch Bag

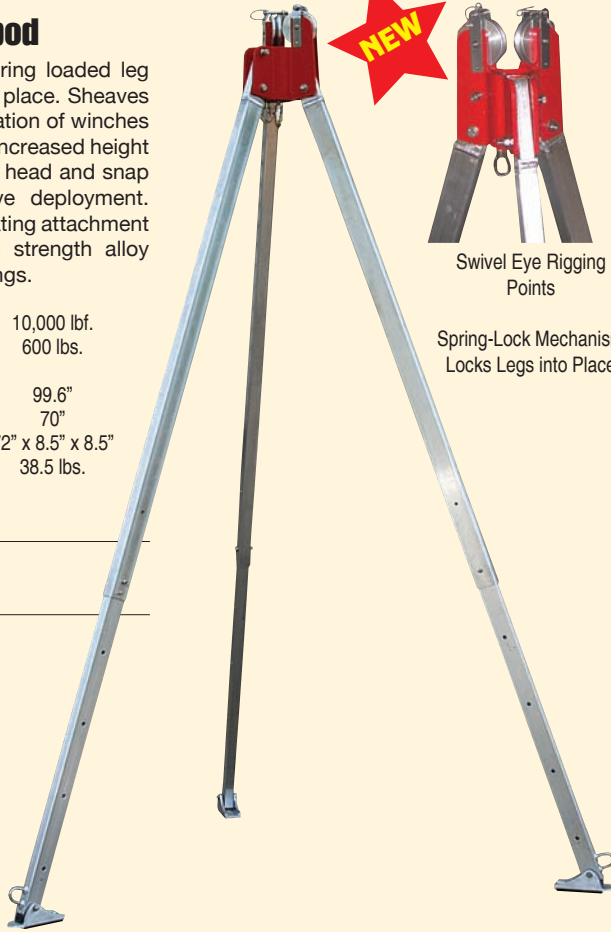

Swivel Eye Rigging Points

Spring-Lock Mechanism Locks Legs into Place



## Sked Evac Tripod

The Sked Evac Tripod extends to 9.9 feet with three anchors at the head. Anchors, Header, and Legs are interconnected with 1/2" Stainless Steel bolts for high strength. At full extension (119") proof load is 5,280 lbf.. At 98" strength is 9,500 lbf. Legs adjustable in 5" increments. WLL at 9 ft.: 528 lbs. WLL at 6 ft.: 950 lbs. NFPA Rating: Light Use. OSHA Rating: 1 person. Bag Dimensions: 89" x 6" x 6".

620510 Evac Tripod  
620511 Carrying Bag for Evac Tripod

## Fall Protection Lifeline with Recovery Winch 3-Way Lifeline

Tough Aluminum housing with 3/16" galvanized steel cable with a load-indicating Autolocking Swivel Snap. Working load: 660 lbf. Meets ANSI Z359.1 and CE BS EN 360 requirements. Electrostatic powder painted. 100% inspected. Unit can be reset from winch mode back to fall protection mode. Attaches to the Technician Tripod with Mounting Bracket.

61943050 3 Way x 50 ft. (shown)  
61943059 Tripod Mounting Bracket



## Fall Protection Lifeline

Great Fall Protection Block for worker and rescuer protection. Meets ANSI and CE Personal Protection Equipment standards.

61942050 Fall Block x 50 ft.  
60511730 Autolocking Carabiner



Mounting Bracket

SalaLift II Winch w/  
Stainless Steel Cable

620515 Retracting Lifeline, 50'  
620516 SalaLift, 60' (1/4" Cable)  
620517 SalaLift II, 90' (3/16" Cable)  
620518 SalaLift II, 120' (3/16" Cable)  
620519 Mounting Bracket\*  
6102118 Cable Pulley\*

60511730 AutoLocking Carabiner\*

\*Required for use of Tripod with Winch or Retracting Lifeline





## Webbing Lanyards

Manufactured from heavy duty 1" wide nylon webbing and two double locking snaps at each end. Minimum Tensile Strength: 5,000 lbf. New labeling and easier to use autolocking snap.

752042	2 ft. Lanyard
752043	3 ft. Lanyard
752044	4 ft. Lanyard
752046	6 ft. Lanyard

Meets all ANSI, OSHA standards and CSA construction requirements.



## Webbing Lanyards with Ladder Hook

Manufactured from heavy duty 1" wide nylon webbing with a double locking snap at one end and a double locking ladder hook (2.5" gate opening) at the other end. Minimum Tensile Strength: 5,000 lbf. Now available with integral shock absorber (Zorber™). New labeling.

752056	6 ft., Snap / Hook (shown)
752348	3-6 ft., Adjustable, Snap / Hook

Meets all ANSI, OSHA standards and CSA construction requirements.



## Webbing Lanyards with Shock Absorber

Lanyards that combine special shock absorber with one of the strongest webbings (10,000 lbf.) available. Webbing features cut indicators on each edge.

753574	4 ft.
753576	6 ft.
752346	3 - 6 ft., Adjustable

Meets all ANSI, OSHA standards and CSA construction requirements



Twin Leg Tower Lanyard, AutoLock

## Twin Leg Tower Lanyards 100% Tie Off

Special design Lanyard with Zorber to be used for 100% tie-off method of climbing safety. One end has a double-locking safety snap or rapid link that attaches to harnesses. The "Legs" of the lanyard are complete with large 2.50" opening double locking Ladder Hooks.

752265	AutoLock, Steel
752265A	Aluminum Autolock, Aluminum
752275	Aluminum with Rapid Link
752264	AutoLock with Shock Absorber

Meets all ANSI, OSHA standards and CSA construction requirements.

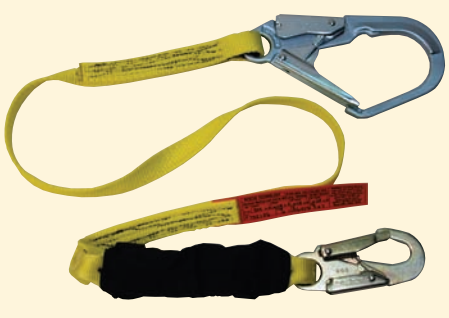

## Shock Absorbing Lanyards with Ladder Hook

Manufactured from heavy duty 1" wide nylon webbing with a double locking snap at one end and a double locking ladder hook (2.5" gate opening) at the other end. Minimum Tensile Strength: 5,000 lbf. Manufactured with integral shock absorber (Zorber™).

752156	6 ft., Snap / Hook / Zorber
--------	-----------------------------

Meets all ANSI, OSHA standards and CSA construction requirements.



## Adjustable Tower Strap w/ Shock Absorber Ideal for Tower/Ladder operations.

The Tower Strap allows the firefighter enough length to complete ventilation or perform window rescues while remaining secured to the bucket or ladder. Used in conjunction with the Truck / Escape Belt or Ladderman's Class II Harness. Adjusts from 4 - 6 ft. and equipped with autolocking snap and ladder hook. Integral Zorber shock absorber limits forces in case of fall. Notice: This product must be protected from temperatures above 250 degrees fahrenheit and direct flame impingement. (Use Fire Resistant Truck Lanyard if in doubt of heat resistant needs)

609015	Adjustable Tower Strap
--------	------------------------



## SITE

### Work Positioning Lanyard

The work positioning lanyard with great handling makes your work safe and efficient. 11mm rope sewn-in unopenable version of LOCKER - rope clamp. Rope covered with tubular webbing to increase wear resistance. Parking cam for locking in required position.

238910112	78 inch
238910114	157 inch



## Lanyard "I"

Made from super-durable 11mm kernmantle rope. Ideal for rope access technicians. Lengths are color-coded at the ends.

23892110060	24 inch
23892120080	32 inch



## Reactor "Y"

*Ideal for Rope Access*

A Twin-Leg static kernmantle rope lanyard with and integrated webbing shock absorber. 1000 lbf. maximum impact force. Complete with Ladder Hooks with 2.25" gate opening. 500 activation force. Minimum breaking strength: 3375 lbf..

2389441155 Reactor "Y", 62 in.



2389422155 Reactor "I", 62 in.



## Access Lanyard "V"

Tested to EN 354 standard for lanyards. It is used for working at height, especially for self-protection when moving from one place to another. The middle loop is attached to the harness with carabiners and energy-absorbing device. Shrink tubing protects each seam. Lanyard V has to be used as a component of a fall arrest system.

		Leg 1	Leg 2
238922101	Small	10"	18"
238922201	Medium	10"	26"
238922001	Large	40"	40"

## Retracting Lanyard

The retractable lanyard is designed to protect personnel working at high levels from falling. The user is attached to the tensioned synthetic webbing enclosed in the drum housing that is attached to an approved anchorage point\*. The webbing retracts automatically providing the worker freedom of movement. Should the worker fall, the inertia locking system engages to arrest the fall.



		Weight
616007	10 ft. Lanyard	42 oz.

Certified CSA X259.2-M Type 1, Class C.

\*Anchorage point must be above connection point on users belt or harness.



## Steel Cable Grab

*Only For Use on 3/8" Steel Cable*

Designed for use on 3/8" diameter steel cable. Manufactured from steel for durability. Can be attached and removed from the cable at any point. Slight spring tension keeps the unit in the locked position unless upward pressure is applied to the pivot arm. Exceeds applicable OSHA/ANSI regulations. Weight: 34 oz.

602700 Steel Cable Grab

## ▲ WARNING

Technical rescue and safety is potentially hazardous. Any person using equipment sold by RESCUE TECHNOLOGY in any manner is personally responsible for learning the proper techniques involved, and assumes all risks and accepts full and complete responsibility for any and all damages or injury of any kind, including death, which may result from the use of any RESCUE TECHNOLOGY equipment.



### RT Extra-Wide Stokes

For those special rescues where the basic sized stretcher will not work. 32" wide at the rail and lined with our 0.25" diamond pattern durathene mesh. Included 4 rescue-grade patient straps\*. Dimensions: 85" x 32" x 8". Weight: 33 lbs.

620125

\*does not replace proper patient packaging using backboard, cervical collar, and headblocks.



Lexan Cover



### Confined Space Stokes Stretcher

An updated version of the traditional wire mesh stretcher. This version features our popular 0.25" durathene mesh insert and rescue-grade straps. Tested to 1500 lbs. Dimensions: 81 1/2" x 18 3/8" x 7 3/4". Weight: 23 lbs. Shipped via motor freight.

620113

\*does not replace proper patient packaging using backboard, cervical collar, and headblocks.



### Stretcher Trailer

Aluminum Litter Trailer for litter transport. Easily disassembles for storage. Nylon Powder Coated. Sets up in approximately 3 minutes. Ground Clearance: 21". Length: 72". Width: 27" or 40". Weight: 71 lbs. Litter not included.

620350

Stretcher Trailer

620355

ATV Adapter Kit



ATV Adapter Kit



### ATR2 Rescue Trailer

The All Terrain Res-Q 2 model was designed for those with limited storage space. The ATR2 features a fully welded chassis made from durable rectangular tubing and schedule 40 pipe with a suspension system consisting of hydraulic assist shocks and coil spring. Towable behind a ATV via the dual hitch configuration. If the ATV does not have a 1-7/8 inch ball, you just slide the hitch out and reverse it and you can attach via standard draw pin style. Standard features are: Split frame with locking pin, Dual Hitch System, 22 x 11 x 8 ATV Tires, Stainless Steel IV Pole, Standard Hubs on Axle, Dual Ratchet Style Straps for attaching stokes litters, 750# capacity coil spring, hydraulic assist shocks. Folds for storage (46" w x 36" d x 63" h). U.S. Patent: 7,131,666.

2394102

ATR2 Rescue Trailer

2394111

Medic Seat

2394113

Lexan Cover

2394115

Medical Tray





## RescueTECH Tapered Stokes Stretcher

The RT Stretcher provides an economical choice for the rescue professional. Cold Rolled tubing and a full length steel strip backing for strength and rigidity. Shipped via motor freight.

- .25" Diamond Mesh insert
- Full length steel strips provide backboard-like rigidity\*
- Rescue-Grade Patient Straps
- Electrostatic Powder Coat Finish

620112 Tapered Stokes Stretcher

*\*does not replace proper patient packaging using backboard, cervical collar, and headblocks.*



## RescueTECH Rectangular Stokes Stretcher

The Rectangular Stretcher builds on our popular Tapered Stretcher design. It is designed to be symmetrical from end-to-end and to allow larger sized, rectangular backboards to easily fit inside. Cold Rolled tubing and a full length steel strip backing for strength and rigidity. Shipped via motor freight.

- .25" Diamond Mesh insert
- Full length steel strips provide backboard-like rigidity\*
- Rescue-Grade Patient Straps
- Electrostatic Powder Coat Finish

620114 Rectangular Stokes Stretcher

*\*does not replace proper patient packaging using backboard, cervical collar, and headblocks.*

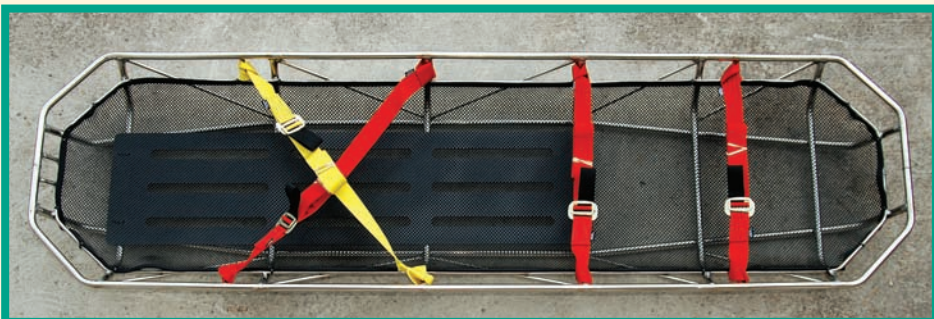

## RescueTECH Stainless Steel Rectangular Stokes Stretcher

A stainless steel version of our Rectangular Stokes Stretcher. Includes a special Mesh insert with a .25" diamond pattern for greater strength, and better patient packaging than .5" patterns. A new style ABS back plate provides a sturdy, yet comfortable base for the patient. We have also added rescue-grade nylon Quick-Fit Stretcher Straps for securing the patient. Shipped via motor freight.

620124 S.S. Rectangular Stokes

*\*does not replace proper patient packaging using backboard, cervical collar, and headblocks.*

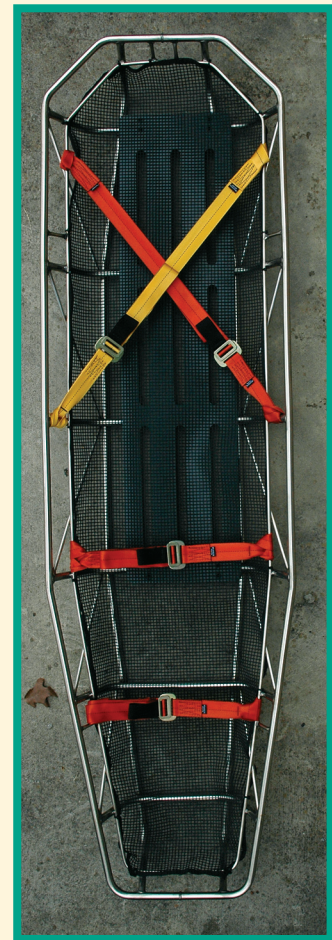

## RescueTECH Stainless Steel Tapered Stokes Stretcher Super Strong to meet Mil-Spec

We designed this stretcher based upon Junkin's top of the line Military Stainless Steel stretcher. This stretcher meets the Mil-Spec 2,500 lb load rating - tested from the ends of the stretcher to give a more accurate measure of strength\*. We add a special Mesh insert with a .25" diamond pattern for greater strength, and better patient packaging than .5" patterns. A new style ABS back plate\*\* provides a sturdy, yet comfortable base for the patient. We have also added rescue-grade nylon Quick-Fit Stretcher Straps for securing the patient. Shipped via motor freight.

620122 S.S. Tapered Stokes

*\*Other brands test from rigging points to give an artificially higher strength rating rather than the required Mil-Spec Strength rating.*

*\*\*Does not replace proper patient packaging using backboard, cervical collar, and headblocks.*

### ▲ WARNING

Technical rescue and safety is potentially hazardous. Any person using equipment sold by RESCUE TECHNOLOGY in any manner is personally responsible for learning the proper techniques involved, and assumes all risks and accepts full and complete responsibility for any and all damage or injury of any kind, including death, which may result from the use of any RESCUE TECHNOLOGY equipment.





**Mass Casualty Flexible Stretcher**

Constructed of specially compounded orange or gray 18oz. vinyl-coated nylon that is easily washed with soap and water.

- Highly resistant to acids, alkalis and penetration of liquids
- Five (5) removable hardwood slats positioned between two layers of the 18oz. fabric provide strength and rigidity
- Shorter slats are placed in torso area only to make stretcher lighter and more compact
- Lightweight – 13lbs.
- Compact and portable – opens to 78”L x 28”W; closes to 35”L x 6”W
- Six (6) handles ergonomically placed for ease of transport
- Three (3) polypropylene web patient security straps for immobilization
- Load capacity – 350lbs.
- Carry bag with shoulder strap
- One person can carry up to ten (10) of these stretchers when responding to an incident

2070104 Orange  
20701047 Grey



**Stadium Seat**

For use in fast, safe transportation of victims from stadiums, sport facilities, arenas, theaters, or anywhere multiple steps create problems in removing patients.

- Lightweight - weighs only 4.5 lbs.
- Strong - accommodates up to 350 lbs.
- Durable - made of 18oz. vinyl and hardwood slats
- Compact - folds to 20” x 7” packaged in carrying bag
- Safe - 2 nylon seat belts secures patient
- Portable - can be stored in a minimum of space
- Easy to use - 5 web handles for lifting and carrying

20700059

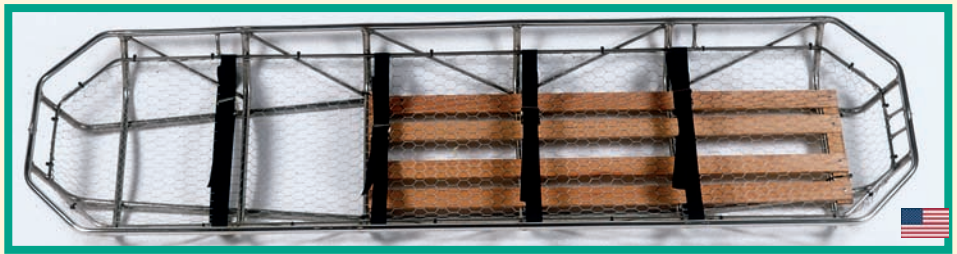

**Stainless Steel Rectangular Litter**

This new heavy duty stretcher combines the stability of the military steel wire basket stretcher with the space needed for a full size rectangular backboard. This is an extremely sturdy lightweight stretcher. Dimensions: 84” x 23.5” x 8”. Weight: 31 lbs. Shipped via motor freight. Tested per Mil-Spec to 2,500 lbf.

620120 Stainless Steel Rectangular Stretcher (JSA-8131W-Miami)

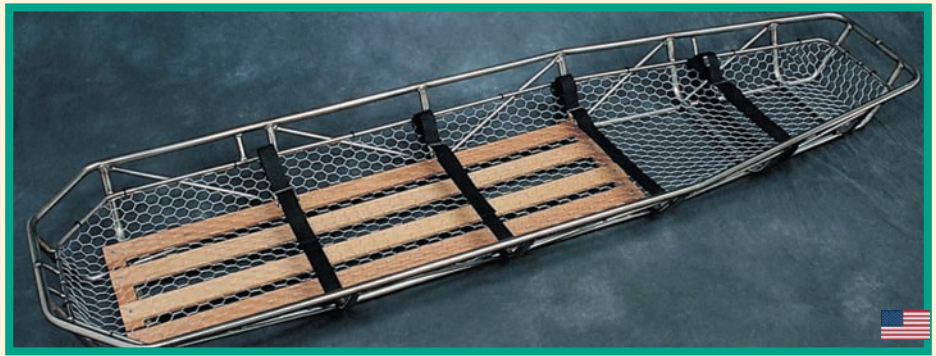

**Stainless Steel Military Litter**

The stretcher used by all branches of the U.S. Military. It is a heavy duty bridge truss design of stainless steel. The wire mesh is replaceable in this stretcher. This stretcher has NO leg divider so a tapered backboard can be used. Length: 83”. Widths: 24” chest, 23” abdomen, 21” calf. Weight: 30 lbs. Shipped via motor freight. Tested per Mil-Spec to 2,500 lbf.

620121 Military (JSA-8131W)  
620123 Military, 2 Piece



**Confined Space Litter**

A narrow version of the Wire Basket Stretcher. Only 19” wide and fits through nearly all accessible manholes. Used with either 4 or 6 point litter bridles. Hexagon mesh wire netting. Tested to 1500 lbs. Dimensions: 81 1/2” x 18 3/8” x 7 3/4”. Weight: 23 lbs. Shipped via motor freight.

620103 Confined Space (JSA-300CS)



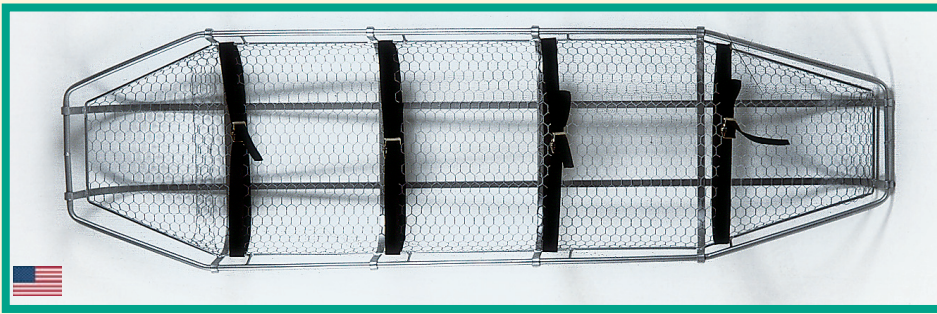

### Wire Basket Stretcher

Traditional design wire basket stretcher manufactured from rugged 5/8" tubular steel frame with 3/16" x 3/4" flat wire braces. Hexagon mesh netting (18 gauge). Used with either 4 or 6 point litter bridle. Tested to 1500 lbs. Length: 80.5". Widths: 22 1/2" chest, 22" abdomen, 21.5" thigh, 20.5" calf. Height: 8". Weight: 31 lbs. Shipped via motor freight.

620101 Wire Basket Litter (JSA-300W)



### Plastic Stretcher

The Plastic Stretcher combines the open top railing desirable on standard wire basket litters with the plastic bottom desired for smooth transport. Made from yellow, high density polyethylene shell, supported by a Stainless Steel outer rail. Shell is permanently attached to rail using semi-tubular Stainless Steel rivets (not pop rivets). Steel rail facilitates handling of the stretcher at all points along sides and ends of stretcher. Includes molded runners and a sealed, closed cell foam pad. The Plastic Stretcher will accept a full size rectangular backboard. Load capacity: 1,200 lbf. Dimensions: 84.5" x 24" x 7.5". Weight: 31 lbs. Color: Yellow. Shipped via motor freight.

620115 Plastic Stretcher (JSA-200)

### Basket Stretcher Flotation Kit

For use with all basket stretchers to provide flotation during patient handling in water. Easily attached with hook and loop fastener to any Stokes type stretcher. Flotation bats are Dow EthaFoam and covered in Cordura™ Nylon. Kit is ready to attach to any Junkin stretcher. Weight: 3 lbs. Color: Orange.

620321 Flotation Kit



### 3 in 1 Basket Litter Bradco Full Body Restraint System

Designed to securely hold patients in a suspended litter bed with wrap-around slings and patient envelope. Replaceable exterior shell protects the litter frame. Excellent for sliding through brush and rocks. Tested to U.S. Army specs. Supports over 2,500 lbf. Weight 22 lbs. Dimensions: 81" x 25" x 8". Shipped via motor freight.

620105 3 in 1 Basket Litter



### ▲ WARNING

Technical rescue and safety is potentially hazardous. Any person using equipment sold by RESCUE TECHNOLOGY in any manner is personally responsible for learning the proper techniques involved, and assumes all risks and accepts full and complete responsibility for any and all damages or injury of any kind, including death, which may result from the use of any RESCUE TECHNOLOGY equipment.



### Patient Stokes Harness

Special design harness that provides inside patient lashing. Designed to stay attached to stretcher then attached to patient. Complete with chest and seat harness section. Easily donned. To be used in addition to a rescue-grade wire basket or plastic stretcher with proper technical rescue patient lashing.

6201540 Patient Stokes Harness



### Stretcher Equipment Pack Holds all Harness and Hardware

A new equipment pack designed to hold all items needed for securing patient and stretcher movement in a vertical environment. Two zippered pockets hold webbing, hardware, litter bridles, victim harnesses, and much more (not included).

Come complete with carrying handle. Stretcher attachment system is complete with high strength buckles. Dimensions: 18" x 10" x 5"

620172 Stretcher Equipment Pack



### Quick-Fit™ Patient Packaging Set

Complete system for patient restraint in the vertical environment. Set includes Stokes Harness, Patient Lashing Set, and Stretcher Equipment pack.

299842121



### Quick-Fit™ Stokes Lashing Set

Packaged set of RescueTECH's Quick-Fit Stretcher Straps. Provides rescue-grade outside lashing for the vertical environment. Complete with 4 red and 1 Yellow strap and storage pouch.

6201530 Stokes Lashing Set



Stretcher not included

### Litter Cover

*Protects Stretcher from the Elements*

Manufactured from durable vinyl coated polyester for extra strength and durability. Double stitched seams and Vislon Zipper. Compression straps secure the bag to the stretcher. Zippered opening of 1/2 of the top panel eases insertion of the stretcher. Dimensions of 90" x 30" x 10" fits all standard and confined space stretchers.

620175 Litter Cover





### Litter Transfer Sling

A handy adjustable sling that attaches to litter railing with a girth hitch. Similar in design to our standard transfer sling. V-ring adjuster attaches to rescuer. Great for litter transport. Extended Length: 40 in. Weight: 8 oz.

756111 Litter Transfer Sling



Handle Set & Stretcher not included

### Mule Litter Wheel

The new Mule Litter Wheel is designed to be truly "universal", and accepts any type and style of rigid litter. The single-wheel design allows for ease of movement in the roughest terrain. Ideally suited for narrow rough trails giving the patient a smooth ride even across slopes. The two securing straps (2 hooks per strap) are each rated to 1,000 lbf. and use a strong and durable ratchet-locking device. The hooks at the end of each securing strap have a one-inch diameter opening which allows you to attach them to any style litter on the market today.

620360 Mule Litter Wheel



Stretcher not included

### Mule Litter Wheel with Handles

This is a modified version of the Original MULE Litter Wheel that adds Handles to both ends of the unit. The single-wheel design allows for ease of movement in the roughest terrain. Ideally suited for narrow rough trails giving the patient a smooth ride even across slopes. The two securing straps (2 hooks per strap) are each rated to 1,000 lbf. and use a strong and durable ratchet-locking device.

620361 Mule Litter Wheel w/ Handle

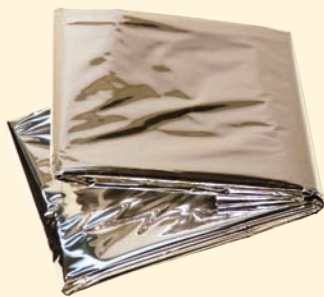

### Emergency Blanket

Known for years as a Space Blanket, this mylar sheet works great as a thermal insulator. Small enough to fit in your shirt pocket, yet opens to a full 56" x 84" size. Stays flexible in freezing temperatures. Wind and waterproof. Weight: 1.5 oz.

2282127032



### Heavy Duty Space Blanket Lightweight Superinsulator

Reflects and retains up to 80% of radiated body heat to prevent post trauma shock resulting from an accident or natural disaster. Waterproof, windproof and durable. Multiple layers are flexible even in sub-freezing temperatures. Dimensions: 60' x 84'. Weight: 12 oz.

620165 Heavy Duty Space Blanket



### Stretcher Blanket Traditional Packaging Tool

The finest cot and stretcher blanket available for patient packaging. Provides excellent insulation characteristics. Note: Proper basket litter operations require a minimum of two blankets. 70% Wool, 30% Synthetic Fiber. Size: 82" x 62". Weight: 2.75 lbs.

620160 Stretcher Blanket





## Adjustable Litter Bridle

*Vertical, Horizontal, and Low Angle Lifting*

Same as our original 4-Point Litter Bridle but with 1 3/4" forged adjusters. Adjusters allow for independent adjustment of the four support straps during rescue. Complete with 3" forged "O" ring and 4 locking litter snaps. Heavy Duty Version features a 30,000 lbf. lifting ring. Also available without snaps to use with heavy duty carabiners for litter attachment. Converts for low angle use. Tensile Strength: 5,000 lbf. Color: Orange with contrasting straps. We suggest the 60511820 RescueTECH Large D, Steel Carabiner. Bridle Kit includes: Bridle, Tender Rope and Carrying Bag.

		Weight
620185	Bridle with Snaps	6 lbs.
620188	Bridle WITHOUT Snaps	2.3 lbs.
620189	Bridle Kit WITHOUT Snaps	5 lbs.
620189S	Bridle Kit w/ Snaps	9 lbs.



## 2-Piece Litter Pre-Rig

The Pre-Rig is a fully adjustable bridle intended for use with any stokes litter. The unique "Y" suspension system drastically reduces congestion at the upper attachment point. Adjustable to a minimum height of 18" above the litter for the tightest helicopter evacuations and a maximum length of 5 feet. One half of the Pre-Rig can be used as a low angle evacuation stretcher harness, eliminating the need to purchase separate harnesses. Combines with a rescuer rigging rope or Transfer Sling for a complete litter/rescuer system. Litter Pre-Rig is made of 6,500 lbf. webbing and quick adjust Mil-Spec forged hardware. Strength: 5,000 lbf. All webbing and hardware meet NFPA strength specifications. Weight: 2.75 lbs.

620183 2 Piece Litter Pre-Rig

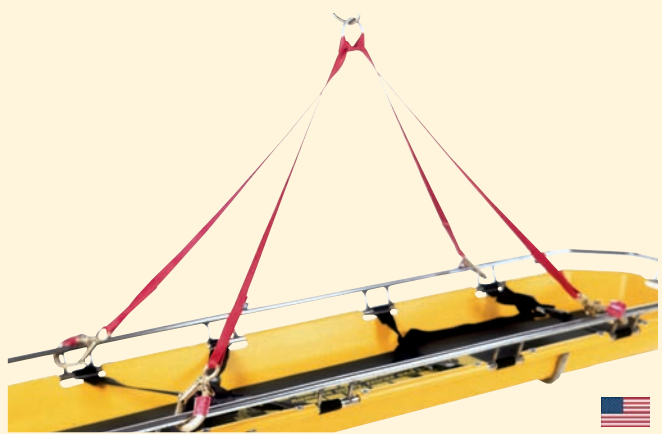

## Convertible Litter Bridle

*Vertical, Horizontal, and Low Angle Lifting*

Ideal for all standard lifting applications. Designed for single rope rigging, the 4-Point Litter Bridle attaches directly to the railing of all types of stretchers. Two 1" heavy duty type 18 nylon slings (Webbing Strength: 6000 lbf.) are looped through a 3" forged steel lifting ring to allow end-to-end height adjustment. Connects to litter with four forged locking snap links (included). WLL: 600 lbs. Weight: 5 lbs. Color: Red.

620180 4-Point Convertible Litter Bridle



## Low-Angle Litter Bridle

Ideal for scree-slope and other low angle litter operations. Provides stable, secure connection. Manufactured of high strength webbing and forged steel hardware. Attaches to sides and end of litter. Strength: 5,100 lbs. Weight: 1.5 lbs. Color: Black.

620181 Low-Angle Litter Bridle

**▲ WARNING**

Technical rescue and safety is potentially hazardous. Any person using equipment sold by RESCUE TECHNOLOGY in any manner is personally responsible for learning the proper techniques involved, and assumes all risks and accepts full and complete responsibility for any and all damages or injury of any kind, including death, which may result from the use of any RESCUE TECHNOLOGY equipment.



## Full Length Backboard



Manufactured of 3/4" weather-proof Marine Plywood finished with two coats of clear varnish. Large hand cut-outs for easy handling. 3/4" runner on bottom for easy lifting. Special shape fits inside Wire Basket Stretcher. Speed clip version requires purchase of up to 5 Speed Clip Straps. Dimensions: 73" x 17" x 3/4". Shipping Weight: 19 lbs.

620201	Full Length
620202	Full Length, Speed Clip Pins
620212R	14" Confined Space (runners)
620231	Straps for Speed Clip Boards



620231 - Speed Clip Straps

## Lightweight Backboard X-Ray Translucent Molded Plastic



Manufactured from the highest grade PVC. Special design is lightweight and easy to clean. Compatible with Patient Restraint Straps and Backboard Strap. Dimensions: 72" x 16". Capacity: 400 lbs. Weight: 15 lbs. Color: Yellow.

620210	L/W Backboard
620211	L/W Backboard, Speed Clip

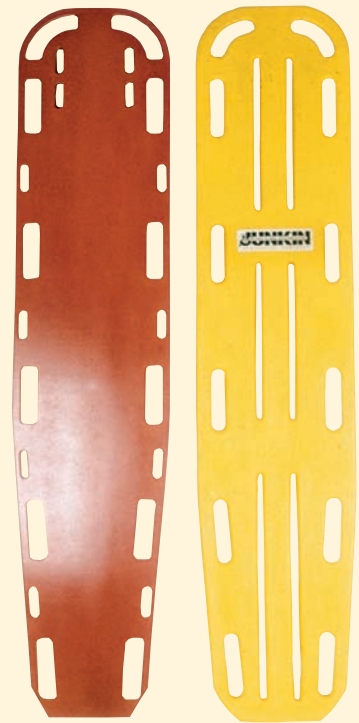

Full Length Backboard

Lightweight Backboard

## Backboard Head Immobilizer

Designed and recommended for immobilization only. Item includes: two head support pillows with ear openings; base with center pad and two backboard retention straps; straps for head positioning; and a vertical stabilization strap to maintain immobilizer placement at head of the board.

620224	Head Immobilizer
--------	------------------

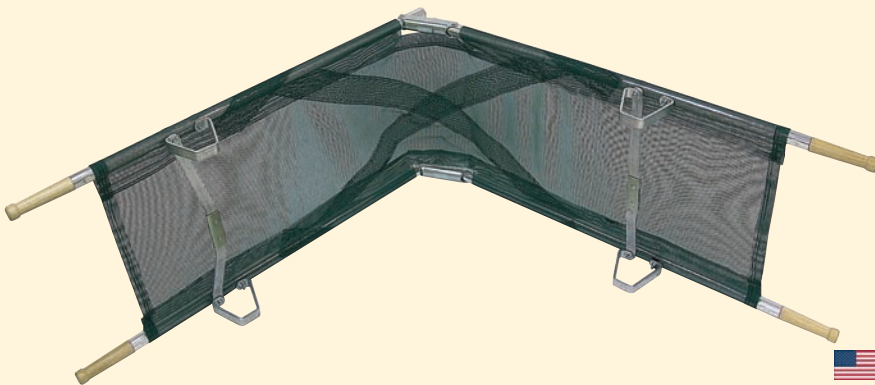
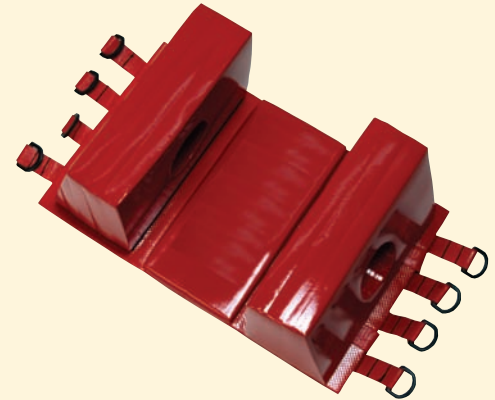

## Aluminum Decon Pole Stretcher Open Mesh Design

Ideal for decontamination. Easily set up and compact for storing. This Medical Corps type litter is light in weight with shaped hardwood handles. Cover is durable 18 oz. vinyl coated nylon.

DIMENSIONS:

Open:	87" x 22" x 4.5"
Folded:	43.5" x 3.5" x 7.5"

2026601M



## AMBU Per-Fit Ace

The Per-Fit Ace adjusts to ANY adult-size neck with 16 different settings ranging from neckless to tall.

- Stores completely flat
- Horizontal sizing line
- Radiolucent, CT & MRI compatible
- Safety buttons for maximum reliability

23466884 AMBU Per-Fit Ace



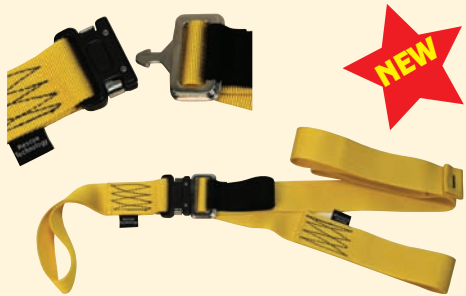

## Clik-Lok 2-Piece Rescue Strap

Manufactured with our new Clik-Lock Buckle, this unit is affixed to backboards and stretchers with a girth hitch. Constructed of 1.75" flat nylon webbing (Tensile Strength: 5,500 lbf. and Clik-Lock adjuster buckles. We recommend crossing the chest area using different color slings to aid in proper buckle attachment. WLL: 600 lbs. Length: 70". Weight: 11.2 oz.

6201512	2-Pc Clik-Lok (Yellow)
6201514	2-Pc Clik-Lok (Red)
6201511	2-Pc Clik-Lok (Black)

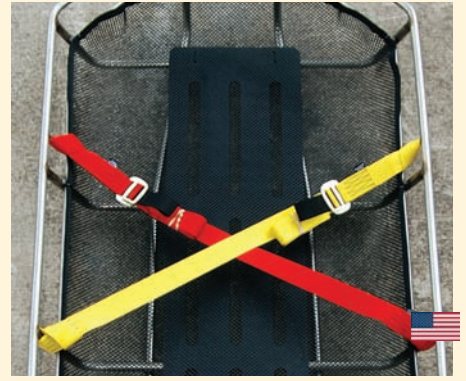
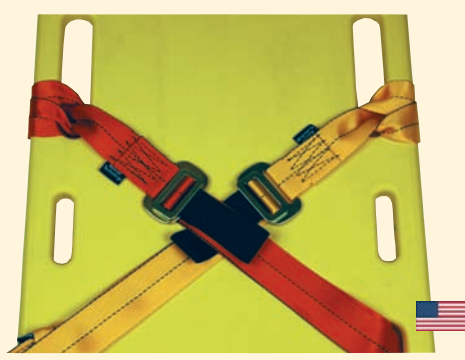

## Quick-Fit 2-Piece Rescue Strap™ For Backboards and Stretchers

A two-piece style strap for use with stretchers or backboards. Consisting of two straps with a loop at one end, to girth hitch around stretcher rail, and a connector at the other end. An excellent alternative to "seat buckle" style connectors. Two-piece buckle is manufactured of steel and require movement in two planes to detach. Easy to connect and adjust. Suitable for Technical Rescue Use. Color: Yellow. WLL: 600 lbs

6201522	2-Pc Quick-Fit (Yellow)
6201524	2-Pc Quick-Fit (Red)
6201521	2-Pc Quick-Fit (Black)



## Patient Restraint Strap

Used with Stokes type basket litters and backboards. Constructed of 2" flat nylon webbing (Tensile Strength: 5,500 lbf.) and cadmium plated self-locking adjuster buckles. We recommend crossing the chest area using one red and one black to aid in proper buckle attachment. WLL: 600 lbs. Weight: 10 oz.

620131	Black
620134	Red

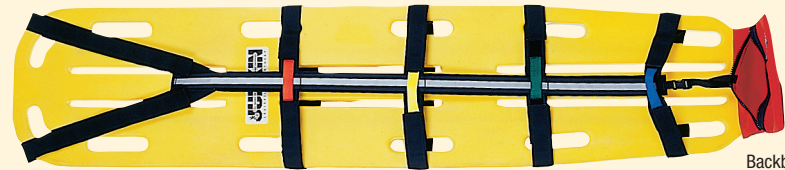

Backboard not Included

## Standard Backboard Multi-Strap Traditional Design

Strap system that has eight straps that quickly and securely immobilize a spine injured patient to virtually any spine board. Easy deployment from included storage bag. Thread straps through the backboard holes and pull tight. Machine washable 1.5" webbing, 1.5" velcro. Reflective striping on center alignment strap. Complete with zippered carrying bag that will attach to backboard or litter for convenient storage. Weight: 22.5 oz.

620155	BackBoard Multi-Strap
--------	-----------------------

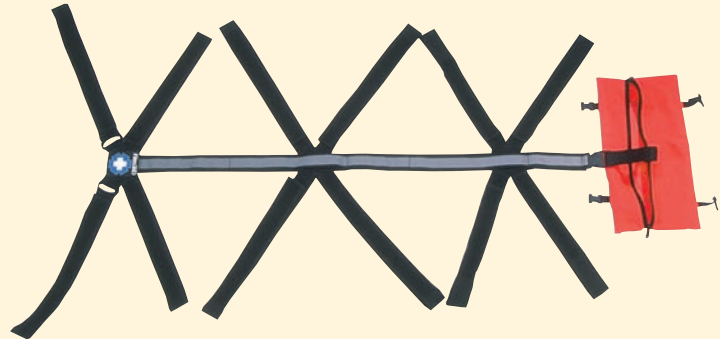

Photo provided by: Conterra

## Triple X Backboard Strap™ Innovative Design from Conterra

New strap system that has twelve separate overlapping Velcro® straps that quickly and securely immobilize a spine injured patient to virtually any spine board. Easy deployment. Simply align the three sets of "X" formation straps over the corresponding weight centers of the body (upper chest, pelvis, legs). Thread tie straps through the backboard holes and pull tight. Machine washable 2" webbing, 1.5" velcro. Reflective striping on center alignment strap. Complete with zippered carrying case. Weight: 28 oz.

621131	Triple X BackBoard Strap
--------	--------------------------

**▲ WARNING**

Technical rescue and safety is potentially hazardous. Any person using equipment sold by RESCUE TECHNOLOGY in any manner is personally responsible for learning the proper techniques involved, and assumes all risks and accepts full and complete responsibility for any and all damages or injury of any kind, including death, which may result from the use of any RESCUE TECHNOLOGY equipment.





## Reeves Sleeve

*Immobilizes Patients for Transport*

A unique product that converts a full size backboard into a patient immobilization device to be used for vertical and horizontal lifting. Perfect device for confined space rescue because it fits over the backboard (not included). DOES NOT CAUSE FEET TO ANGLE OUTWARD as do popular plastic lifting devices. Sleeve material is a vinyl laminated nylon that meets Mil Spec C 4300 Type 1, Class 1 anti-fungal vinyl and is resistant to acids, alkalis, and liquids. Lifting straps are constructed from 6,000 lbf. Tensile Strength webbing. Reeves Sleeve II has extra webbing reinforcement for greater strength. Storage Dimensions: 24" x 12" x 5". Full Dimensions: 73" x 24". Weight: 14 lbs. Color: Orange.

620401	Reeves Sleeve
620401S	Reeves Sleeve, Metal Buckles
620401R	Reeves Sleeve, Reinforced
620402	Reeves Sleeve II
20700049	Replacement Head/Chin Strap

*Note: This product, when used with a quality backboard, provides the best medical access of any confined space immobilization devices.*

## Reeves Sleeve Drag Version

A special conversion of the traditional Reeves Sleeve that adds a special drag sheet. The sheet reduces drag and protects the sleeve in rough environments.

620403	Reeves Sleeve Drag Version
--------	----------------------------



## SPECpak™

*Improved - Now with Void Filling Foam Blocks*

Unique Patient Packaging and Extrication System combines' backboard immobilization of a "Short Board" along with the suspension and support of a full body harness. The PAK System utilizes an integrated polyethylene board along the back of the harness system to reduce wear and allow for a smooth sliding surface for confined space operations. Grab handles located on the sides and head of PAK aid rescuers during movement of patient through confined spaces. Pack System is very useful for any confined space operations where a vertical environment is encountered. SPEC PAK is a fully certified lifting harness (ANSI Z359.1-1992), thus eliminating the need for a separate victim harness. Unique self-adjusting cervical restraint eliminates the problem associated with lifting patients vertically while secured to a rigid backboard. NEW head pad system helps prevent hyper-extension of cervical area. SPEC PAK is only intended as a limited spinal immobilization system. SPEC PAK must be used with proper spinal immobilization such as the use of a "Cervical Collar" where conditions and protocols dictate.



620410 SPECpak



## LSP Half Back™

A versatile short body immobilization board designed for suspected cervical/spinal injuries during confined space rescues. Leg straps support lower body during lifting. 6 handles. Closed cell foam interior and metal back stay. Weight: 11 lbs.

2322710	LSP Half Back
2322711	Vertical Lift Straps for LSP
2322716	Half Back Carrying Case



## Miller Body Splint™

Complete with a full head and body restraint harness. Rigid foam core provides both strength and buoyancy (will float 250 lbs. in fresh water.) Split leg design.

2154700	Miller Body Splint
2154720016	Carrying Case





**Oregon Spine Splint II**

Absolutely the best spinal immobilization / extraction device available. Preferred to K.E.D., XP-1, and LSP. It immobilizes the spine and the shoulders at the same time. When applied it allows easy access to the patient's chest or abdomen for treatment or diagnosis. The chest straps hold the patient more securely than other devices, but does not restrict breathing. It folds up extremely small to fit in its carrying bag. Non-absorbing materials for easy cleaning. Weight: 10.6 lbs.



- 620500 Orange (SK-300-OR)
- 620500OD Olive Green (SK-300-OD)



**Sked Haz-Mat**

A SKED designed for mass casualty and Haz-Mat Use. Complete with cut-in hand holds and disposable slings. Stretcher is easily decontaminated.

- 620416 Sked Haz-Mat (SK-250)
- 620417 Body Only (SK-251)
- 620418 Haz Mat Straps (SK-252)
- 620419 Deployment Case (SK-253)



**Sked® Stretcher**

The SKED® basic system includes the SKED® stretcher, Cordura™ backpack, horizontal and vertical lift systems, tow strap and webbing handles. Requires Backboard for proper patient immobilization. Excellent in rescues which require the unit to be dragged through a narrow space. Weight: 16 lbs. Color: Orange.

- 620415 Sked Stretcher, Complete - Orange (SK-200-OR)
- 620415OD Sked Stretcher, Complete - Olive Green (SK-200-OD)
- 620520 Sked Pediatric System (SK-400)
- 620420 Half Sked Patient Drag (SK-220)
- 620450 Sked Flotation Kit (SK-600-OR)
- 620452 Sked Rapid Deployment Conversion Kit (SK-651-OR)



**Haz-Mat Patient Transfer System**

Includes everything needed for a rapid evacuation of mass casualties in a haz-mat environment. Includes continuous loop shuttle rope for distances of 100', 150', and 200'. The system allows as many as 4 rescuers in Level A suits to load patients onto the shuttle. System includes: 12 HMD Sked Stretchers, Rescue Winch System, 2 Knot Passing Pulleys, 14 Carabiners, Accessory Cord, 8 Rope Grabs, and 100' Extension Cord w/ Reel.

- 21172520 Patient Transfer System





New Anatomical Head Shape\*

Lifting Loop

15 oz. Rot-Resistant Canvas Shell

Nylon Inner Shell



Weight Label

Thermal Imaging Training Vest (optional accessory)

Thermal Packs for Imaging Vest (optional accessory)

Injury Arm Bands (optional accessory)



## Water Rescue Manikin

Built to the same tough construction standard as the General Use Manikin, the water rescue is built to simulate an unconscious victim in the water, floating at an angle of 45 degrees with just the head and shoulders above the water. The head is color-coded with a yellow "face". Strong plastic strips in the manikin run from the shoulders to the knee and maintain overall flexibility but don't allow the manikin to "flop" in half. The outer carcass is constructed of heavy duty open mesh reinforced with webbing. Additional weight may be placed in special pouches to allow the manikin to sink. Available in Man-Overboard Orange w/ SOLAS reflective strips or Search and Rescue Black. Adult: 5'11"; Youth: 4'3".

23952040	Adult, Orange	88 lbs.
23952020	Youth, Orange	44 lbs.
23952140	Adult, Black	88 lbs.
23952120	Youth, Black	44 lbs.

Poly/Cotton washable Coverall

Nylon Reinforced PVC fabric "hands"

High Density Polypropylene webbing on stress points

Lug-sole boots on 44 lb., 66 lb., 110 lb., and 154 lb. models



\*All manikins except the 11 lb. and 22 lb. models.

## General Purpose Training Manikin

*More Realistic Performance / Weight Vest Provides Variable Weight*

Rugged, realistic in size, weight distribution and handling characteristics. Manufactured using a flexible inner core, an outer shell, and protective overall. The inner core is weighted to human proportions using 4.4 lb weight packets. For structural integrity, the packets are sewn to a nylon "inner dummy" with all the body parts (arms, legs, chest, etc.) held in place with webbing. The outer layer is 15 oz. Rot-resistant Canvas. All seams are double stitched and reinforced with webbing for improved abrasion resistance. The included protective coveralls protect the manikin from dirt and abrasion and are reinforced with high strength webbing in high stress areas. All manikin 44 lbs and up are supplied with lug sole boots that are secured to the manikin. Optional weight vest fits underneath the coverall and allows weight to be added or removed as needed to achieve the desired Manikin weight.

Description	Weight	Height
23951005	11 lbs.	2' 3"
23951010	22 lbs.	2' 10"
23951020	44 lbs.	4' 3"
23951030	66 lbs.	5' 11"
23951050	110 lbs.	5' 11"
23951068	150 lbs.	5' 11"
23951100	220 lbs.	5' 11"

Replacement Reinforced Coveralls	
23959605	Repl. Coverall - Infant
23959610	Repl. Coverall - Toddler
23959620	Repl. Coverall - Youth
23959650	Repl. Coverall - Adult*
23959670	Repl. Coverall - Heavy Adult

23959701 Replacement Boots

\*fits both Light and Standard adult manikin



## Training Manikin Weight Vest

*For Adult Training manikin*

Special Low-Profile design fits underneath manikin coveralls. Quickly and securely fitted to manikin. Allows one manikin to do the work of many. Now, both heavy and lightweight training needs may be met with a single manikin. (Shown outside of coveralls for clarity).

23959215	15 lbs.
23959225	25 lbs.
23969236	36 lbs.



## Manikin Storage Bag

A custom-designed bag to fit the youth - Heavy Adult Sized RescueTECH Training Manikins. Features Heavy Duty PVC material and nylon straps. Includes Shoulder straps and end lifting handles

23959104 Storage Bag, Youth / Adult

RESCUE TECH

www.rescuetechn1.com





**NEW**

## FR Training Manikin

### Fire Resistant Body and Coveralls

This high quality, flame resistant manikin demonstrates a balance between temperature and abrasion resistance. Constructed using a blend of Kevlar/Nomex for the inner core and Kevlar for the outer carcass. The protective coveralls are made using PBI Gold which provides excellent heat and abrasion resistance. All FR training manikin are now fitted with heat resistant Firefighters safety boots supplied by Hunter boots, the boots greatly extend the life of the dummy protecting the legs if the dummy is dragged along the ground. Height: 5' 11".

23953030	66 lbs.
23953050	110 lbs.
23959830	Replacement Coveralls, 66 lb.
23959850	Replacement Coveralls, 110 lb.



**NEW**

Simulates Full and Partial Amputation of Leg and Arm

C-Collar not included  
Includes Coveralls (not shown)

## Multi-Trauma Training Manikin

The Multi-Trauma Rescue Manikin evolved from the Blast and Impaled Victim manikin to combine all the features of these manikin in one product. Additionally, the head has been redesigned to allow the fitting of an extrication collar. So now you have in one manikin a General Purpose rescue manikin that can also simulate an amputated arm and leg, an impaled torso and a suspect neck injury.

The hole on the left of the torso allows a spike to be firmly held in place. The right arm and right leg are fully detachable to simulate an amputation, or by partially releasing the locking straps the limb can be weakly attached and will fall off if the rescuer does not correctly assess and support the injury. The manikin is supplied complete with sturdy boots that greatly protect the legs if the manikin is dragged along the ground, and are user-replaceable if badly damaged.

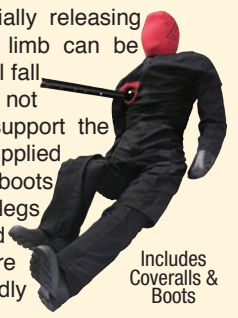

Includes Coveralls & Boots

23956030	66 lbs.
23956050	110 lbs.
23954905	Replacement Leg
23954901	Replacement Arm



**NEW**

## Thermal Imaging Training Vest

Vest designed to aid in thermal imaging training. Low profile design fits underneath coveralls of FR Manikin. (Shown outside of coveralls for clarity).

23959301	Thermal Imaging Vest
23959303	Thermal Packs, Set of 2



## Simulaids Training Weight Vest

Designed to replace SCBA Packs and gear during physical Training. Available in Small, Medium/Large, XLarge. Specify Size.

Size	Chest
SM	30-34"
MD	36-42"
XL	44+

21541112X	20 lbs.
21541114X	30 lbs.
21541115X	40 lbs.



## Simulaids / I.A.F.F. 50 Lb. Training Weight Vest

A specially designed (with the assistance of the I.A.F.F.) weight vest to aid in firefighter physical ability testing. The 50 lb. vest simulates the weight of protective clothing and SCBA. Pouches on shoulders accept additional 25 lbs of weight to simulate hose bundle. New design offers better fit and greater comfort for firefighter.

Size	Chest
SM	30-34"
MD	36-42"
XL	44+

21541118	Small
21541120	Medium/Large
21541125	XLarge
21541000	Extra Shoulder Wgts, 25#



## "Large Gentleman" Bariatric Training Manikins

400 lbs of Realistic Flabby Performance

Designed to achieve a 'fluidity of movement' that simulates an obese patient. The Large Gentleman is based around a 220 lb General Purpose Manikin, the extra bulk is built up with several weighted layers separated by Nylon coated padding. Rather than just adding a 180 lb. 'lump', we have distributed the extra weight around the body in 170 x 1 lb. packets of steel shot (a very time consuming process!). The Nylon coating on the padding allows the different layers to slip and slide over each other creating a real feeling of 'flabby skin'. Includes reinforced coveralls and Boots AND Drag Sheet. Weight: 400 lbs. approx. Ships via Motor Freight Only



23951180 Large Gentleman  
29963144 Bariatric Carrying/Drag Sheet



### Casualty Training Armbands

Provides Identification of Injuries

MCI casualty Armbands for Training manikin. Includes one each: Head, Arm, Leg, Neck, Back, Chest.

23959501 Arm Bands, set of 6



New Anatomical Head Shape

Included Reinforced Coveralls are easily removed and replaced.

### Haz-Mat Rescue Decon Manikin

Heavy Duty, Water Resistant Outer Shell

The HazMat Rescue Training Manikin is based upon our popular General Purpose Training Manikin. Available in 66 lb. and 110 lb. models. The internal construction is basically identical to the General Purpose Manikin, but the HazMat Manikin has an outer carcass made from tough, nylon reinforced PVC. This material is designed to withstand being heavily doused with water during a chemical spillage exercise or laying in water during a storm water drain or cave rescue exercise. In fact, it is useful in any scenario where the manikin has to endure a constantly wet environment. The HazMat Manikin has no flotation so where scenarios are in deep water, the use of our Water Rescue Manikin is indicated. Supplied with a coverall of polyurethane coated polyester with polypropylene webbing in high stress areas. At the end of the exercise, simply hose down the whole manikin and hang up using the integral lifting look at the back. Replaceable reinforced coveralls and Lug-Sole Boots. Anatomical Head.

23957130 66 lbs  
23957150 110 lbs.



### Drag Harness for Rescue Manikin

A Full Body Harness with added shoulder handles for use with the Training manikins. Fits all Adult size manikin

718130 Manikin Drag Harness



**Rescue Randy**

**Official Manikin of the Firefighter Combat Challenge**

Molded of durable vinyl plastic. Built with 4,200 lbf. test plastic coated cables. Articulated Joints. Weight distribution according to human weight distribution chart. Used by U.S. Military, Fire and Police Departments, Safety Teams, and Emergency personnel for rescue and extrication. Ideal for Tower, Confined Space and Trench Rescue.

	Description	Weight	Height
21544175	Rescue Randy IAFF	165 lbs.	56"
21544165	Rescue Randy Combat Challenge	165 lbs.	56"
21544145	Rescue Randy Combat Challenge	145 lbs.	56"
21545200	Rescue Randy IAFF	200 lbs.	56"
21545175	Rescue Randy IAFF	175 lbs.	56"
21545125	Rescue Randy IAFF	125 lbs.	56"
21544105	Rescue Randy	105 lbs.	50"
21544055	Rescue Randy	55 lbs.	50"
21541355	Rescue Jennifer	16 lbs.	49"
21541355R	Rescue Jennifer II	38 lbs.	49"
21542094	Storage Bag, Combat Challenge		



**⚠ WARNING**  
 Technical rescue and safety is potentially hazardous. Any person using equipment sold by RESCUE TECHNOLOGY in any manner is personally responsible for learning the proper techniques involved, and assumes all risks and accepts full and complete responsibility for any and all damages or injury of any kind, including death, which may result from the use of any RESCUE TECHNOLOGY equipment.



**Flexible Rescue Randy**

This regular-sized Rescue Randy unit has been developed especially for the aero-space industry and wing tank fuel cell rescue training, but it can be utilized in any confined space rescue. It exceeds the flexibility of the Regular Rescue Randy products (1300 series item numbers) because the waist flexes and the head twists to allow positioning of the manikin under dashboards, in tight spots, and under things where the Regular Randy will not go. Flexible 5 ft. 5" Rescue Randy. Size: 50" x 21" x 12". Shipping Weight: 60 lbs.

21542710

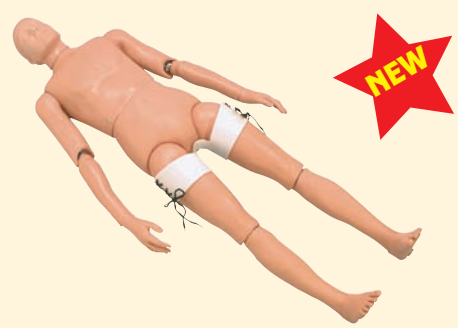

**Randy Intervention Truss**

Designed with the Rapid intervention Team (RIT) and confined space rescues in mind, this adjunct to the Rescue Randy eliminates strap pressure applied to the groin area of the Randy when harness straps pass through the manikin groin area. After the device is attached to the manikin thighs, the harness or waist strap that is passed through the groin during exercises will not hinder the structure of the manikin skeleton, which causes degradation of the pelvis. Use this inexpensive product to protect the investment you made in your Rescue Randy.

21541479

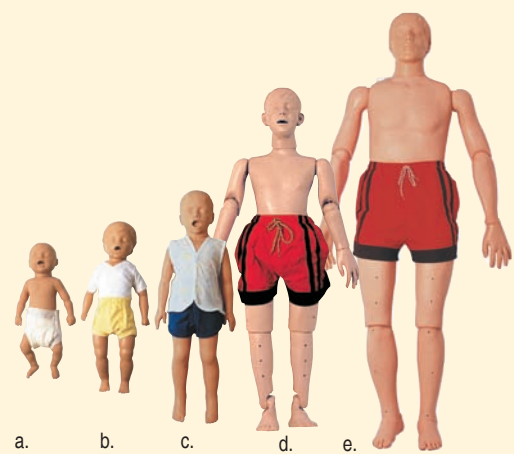

**Water Rescue Training Manikin**

Used by the U.S. Coast Guard, Sheriff's Departments, Lifeguard Trainers and Emergency Personnel for both on water and in water rescue and retrieval. Manufactured of durable vinyl plastic with rust resistant steel skeleton (adult and adolescent models). Articulated joints on Adult and Adolescent. When filled with water manikin will submerge to neck. Add an additional 5 - 10 lb weight (not supplied) to sink.

21541326	Adult	65 x 23 x 9"	52 lbs.
21541327	Adolescent	49 x 16 x 9"	22 lbs.
21541351	3 Year Old	34 x 11 x 7"	10 lbs.
21541352	6 - 9 Month	26 x 8 x 8"	7 lbs.
21541350	Infant	22 x 8 x 8"	5 lbs.



## USAR-TECH Rope & Equipment Pack

A full backpack style equipment storage/carrier. Features a rope bag section with room for 200 ft. of 1/2" Access Lifeline PLUS space for a pre-rig rescue system. This feature is easily accessible without opening the main compartment. The main compartment features RescueTECH's exclusive "expanding compartment" storage system. The system effectively doubles the storage space for webbing, slings, and rope guards by placing a divider in the main compartment. Adjustable Shoulder and waist straps will accommodate all rescuers. Waist pads will actually expand to fit larger waists. The semi-rigid internal frame supports gear. All straps may be tucked into special storage areas to prevent tangling with other equipment in the compartment. Manufactured in our Georgia facility from fabric made from Dupont Cordura Brand fibers. Dimensions: 20"h x 18"w x 10"d.

808326	Blue
808324	Red
808321	Black
808320	Orange



First equipment section opens to show webbing, sling, and rope protector storage section



Equipment not included



Equipment not included

Opening the divider reveals additional sling storage and mesh compartments for hardware and rigging supplies.



Rope and Pre-Rig Accessible from exterior through our rapid access opening

## USAR-OPS Rope & Equipment Pack

A slightly smaller version of our popular USAR Rope and Equipment Pack, the Standard Rescue pack is durable and versatile. 4 interior mesh pockets securely hold small items. Outside 'slash' pockets and full width interior pockets give ample storage space for rope pads, slings and webbing. Horizontal strap system allows for attachment of pulleys and carabiners. Holds 150' of 1/2" rope and pre-rig in rope section. Padded shoulder straps and waist strap are comfortable and easily stowed for bag storage. Dimensions: 20"h x 16"w x 10"d.

808334	Red
808336	Blue
808331	Black



Side View:  
Padded Shoulder Straps and  
Slash Pocket



Back View:  
Stowed Shoulder  
Straps.



Interior View:  
multiple mesh  
pouches,  
attachment  
straps and  
slot pocket.

RESCUE TECH

www.rescuetechn1.com





Equipment not included.



## Deluxe Equipment Pack

An innovative pack designed to provide organized storage and convenient transport of rescue equipment. The main compartment (11" w x 16"h x 6"d) is fully padded with closed cell foam and has webbing loops to attach equipment. The pack has a webbing carrying-handle and padded contour shoulder straps. A false back stores the shoulder straps when not in use. A front outside compartment is 15"h x 10"w x 3"d. The compartment has a sleeve for a rescue rack. Weight: 2.2 lbs.

808300	Orange
808304	Red
808306	Blue

## Rescuer Equipment Pack



A larger version of our Deluxe Equipment pack. Larger dimensions along with our Expanding Compartment Storage System gives rescuers extra room for needed equipment. 5 Mesh Pockets and 2 equipment loops. Padded stow-away shoulder straps. Self-Healing #10 industrial zipper. Dimensions: 20"h x 16"w x 5"d.

808344	Red
808346	Blue



Side View:  
Padded Shoulder Straps.



Back View:  
Stowed Shoulder Straps.



Interior View:  
multiple mesh pouches, attachment straps and slot pocket.

**⚠ WARNING**

Technical rescue and safety is potentially hazardous. Any person using equipment sold by RESCUE TECHNOLOGY in any manner is personally responsible for learning the proper techniques involved, and assumes all risks and accepts full and complete responsibility for any and all damages or injury of any kind, including death, which may result from the use of any RESCUE TECHNOLOGY equipment.



## Equipment Saddle Bag Organizes Equipment

A modular accessory for our rope bags. Organizes technical gear into a convenient deployment package. Fits our medium, large, and extra-large size rope bags. The Saddle Organizer pockets are 8" x 4" x 20" with #10 zippers and a clear vinyl window for inventory lists. External Mesh Organizers for quickly needed items. Weight: 1.25 lbs. Rope Bag not included.

808901	Equip. Organizer (Black)
808904	Equip. Organizer (Red)
808906	Equip. Organizer (Blue)



Equipment not included

## Equipment Cache

A handy storage pack for quickly needed rescue equipment. Padded sides, 4 Mesh Pockets, 8 equipment loops. Dimensions: Closed: 23" x 12" x 4"; Open: 23" x 24" x 2".

811339	Equipment Cache
--------	-----------------





Equipment not included.

### Deluxe Search & Rescue Pack

The big brother of the standard SAR pack with several useful additions. There are also lash points on the front for additional gear. Behind the lashing is a pocket to carry a water reservoir. The rope compartment carries over 300 feet of 1/2" rope, and a pocket in the hood holds maps, a compass, GPS, and glasses. There's also a water bottle carrier on the hip pads. Internal volume: 3400 cu. in. Dimensions: 31"h x 10"w x 9"d

808954	Deluxe S.A.R. Pack (Red)
808956	Deluxe S.A.R. Pack (Blue)

### Standard Search & Rescue Pack

For Search and Rescue or Confined Space Operations. The S.A.R. Pack hauls equipment in a technical climbing designed semi-stayed internal frame backpack. When you need your gear, everything is laid out for rapid deployment. The rope is compartmentalized, and there are two large pockets for BLS gear, harnesses, and other equipment you need on the mission. Holds up to 200 ft. of 1/2" Rope. Weight: 4.25 lbs. Dimensions: 24"h x 10"w x 9"d.

808941	S.A.R. Pack (Black)
808942	S.A.R. Pack (Yellow)
808944	S.A.R. Pack (Red)
808945	S.A.R. Pack (Green)
808946	S.A.R. Pack (Blue)



Equipment not included.

### Rescue Pack

Top of the line backpack rescue organizer. Neatly organizes individual rescue equipment on a panel style pack. Internal frame and adjustable shoulder, sternum, and waist straps. Two Models: Technical Rescue Equipment Pack for equipment only. High Angle Rescue Pack for Equipment and 200 ft of 1/2" Rope. Dimensions: 18"W x 24"H x 14"D.

808926	Technical Pack (Blue)
808936	High Angle Pack (Blue)



### RT Duffel Bag

A traditional cylinder bag built with the same high quality and durability as all of our rope and equipment bags. Manufactured from our RescueTECH™ super tough fabric. Seams are double-stitched and taped for superior strength.

LARGE: 20" x 10"		XLARGE: 24" x 14"	
8063140	Orange	8063150	Orange
8063141	Black	8063151	Black
8063144	Red	8063154	Red
8063146	Blue	8063156	Blue
		809790	Shoulder Strap, Adjustable



### Double End Rope Bag

Made from Cordura™ Nylon w/ grab and throw loops. Drawstring openings at both ends allow user to "rotate" the rope using both ends equally. Manufactured in U.S.A. Color: Black.

		Capacity
804201	Small	150 ft. of 1/2"
804301	Medium	200 ft. of 1/2"
804401	Large	300 ft. of 1/2"





## USAR Task Force Member Pack

### A Multi-Use Personal Equipment Pack

Designed at the request of a Southeastern USAR Team, the pack keeps Helmet, Class III harness, Carabiners, Webbing, Gloves, Accessory Cord, Goggles and other personal gear ready for deployment. Manufactured of High Strength Polyester fabric. Padded on all sides to protect contents. "D" rings on end accept shoulder straps. We can even fill it with the equipment that you need. Dimensions: 24 x 12 x 10"



29962101	USAR Member Pack
809790	Shoulder Strap



PFD's not included

## Mesh PFD Bag

The Mesh PFD Bag makes it easy to transport and store your damp and difficult-to-carry gear. The top of this bag is made with the same 2-1/2" square mesh netting so that everything inside dries quickly. The bottom is 500 denier PVC for durability. Two sturdy handles and a quick-cinch draw cord opening allow you to pick up and go. Room enough for all your friends' gear, too. Holds up to 18 PFDs. Dimensions: 40"W x 40"L x 30"H

20843094

## RescueTECH Rescuer Gear Bag

We took the time to design a bag that a rescuer could keep personal gear ready to go. The main section has a zipper system that allow quick and full access to the contents. The large end pouch will hold an R3 Kiwi helmet, but can also be used for a change of clothes, harness, and other rescue items. The small end pouch works great for gloves, slings, etc. Side pockets hold other personal gear. A zippered see-through panel can be used for personal identification and allows the bag to be used and marked as a specific use rescue kit. Includes adjustable shoulder strap. Dimensions: 25 x 12 x 10". Color: Black



Equipment not included

809741	Black
809744	Red



Includes Shoulder Strap

## RT Gear Bag Heavy Duty Carrying Handles on Ends

A large Duffel design easily stores turnouts, helmet and boots. Great for all rescue personnel. The two-way wrap around zipper allows you to open bag all the way for easy access to contents. A large zipper pocket outside gives you extra storage for personal items, gloves, tools and goggles. Two inch webbed handles wrap completely around the bag to give extra support. Dimensions: 12" x 16" x 23". Color: Red. Weight: 1.5 lbs.



Equipment not included

809704	Gear Bag
--------	----------



Equipment not included



## RT Gear Pack Stowaway Padded Shoulder Straps

Based on our popular Gear Bag design, we added shoulder straps to make it easier to move this pack around. Easily stores turnouts, helmet and boots. Great for all rescue personnel. Two-way wrap around zipper allows you to open bag all the way for easy access to contents. A large zipper pocket outside gives you extra storage for personal items, gloves, tools and goggles. Two inch webbed handles wrap completely around the bag to give extra support. Dimensions: 12" x 16" x 23". Color: Red. Weight: 1.5 lbs.



809844	Gear Pack
--------	-----------



## Hall County SCBA Mask Bag™

After many months of searching and evaluation, Hall County Fire (Georgia) decided upon this design to protect their SCBA masks. Made of durable 1000d Cordura™ fit their needs to a “T”. Closed with a durable #10 Zipper instead of Velcro™ for a long service life. Hall County chose to line the interior with a smooth, coated 200 denier nylon fabric instead of a fleece material. Their evaluations concluded that while the fleece was soft, it trapped dirt and contaminant in the material and between the inner and outer layer. Features a bottom grommet for drainage and a hook and loop strip to attach name plates or accountability tags. A durable 1” wide nylon webbing loop allows the bag to be attached to turnout gear or hooks in the apparatus or equipment lockers. Dimensions: 13.5” x 6.5”



832104 Hall County SCBA Mask



Harness Rigging Pouch shown on Corona™ Escape Belt

### Harness Rigging Pouch

A great addition to a rescuer’s gear selection. The Rigging Pouch attaches to the waist belt of a rescue harness and provides quick access to often used equipment. Padded sides. Holds carabiners, slings, pulleys, etc. Easy access while “on rope”. Locking Zipper prevents accidental opening. Inside features rigging loop and snap closure mesh pouch. Dimensions: 9.5 L x 7” H x 3” D. Weight: 11 oz.. Equipment not included.

800201 Harness Rigging Pouch



### Harness Equipment Pouch

Our newest personal Harness Pouch. Designed to hold the many tools required by rescue technicians. The main pocket has a special collar closure that is secured with a cord lock. The front bellows pouch can hold quickly needed equipment. An exterior gear loop and mesh pocket multiplies the uses of this high quality bag. Dimensions: 8” L x 6.5” x 4.5” D. Weight: 12 oz.. Equipment not included.

800214 Red  
800211 Black



### Basic SCBA Mask Bag

A basic, envelope-style SCBA mask Bag. Made from highest quality 300 x 600 PVC coated nylon fabric for durability and water resistance. Full width hook and loop fastener keeps the contents clean and ready for use. Steel ring allows firefighter to attach this bag to turnout gear with a simple key-ring carabiner. Fits most mask-regulator style SCBA Masks (Scott®, Interspiro®, etc.) Color: Red. Bags may be ordered with embroidery (25 unit minimum). Call for details. Dimensions: 14” x 10” x 4”.

8321015 Basic Mask Bag



Equipment and harness not included.

### Lanyard Pouch

For lanyards, personal escape rope, gloves, and miscellaneous small equipment. Constructed of Cordura® nylon with fold over hook and loop closure. Built-in loops fit belts up to 4” wide. Holds 40 feet of 3/8” or 75 feet of 7mm nylon tag line or Titan Cord. Dimensions: 8” x 5” x 3”. Color: Black. Weight: 2.4 oz.

800101 Lanyard Pouch



Equipment not included.

### Deluxe Lanyard Pouch

Great for search kits. A larger version of our popular Lanyard Pouch. The Deluxe Lanyard Pouch features a “hinged” lid with a “hook and loop” closure. Holds up to 80 ft. of 8mm cord. Dimensions: 11” H x 7” W x 3” D. Color: Black, Orange. Weight: 3 oz.

8001151 Black  
8001150 Orange

## ▲ WARNING

Technical rescue and safety is potentially hazardous. Any person using equipment sold by RESCUE TECHNOLOGY in any manner is personally responsible for learning the proper techniques involved, and assumes all risks and accepts full and complete responsibility for any and all damages or injury of any kind, including death, which may result from the use of any RESCUE TECHNOLOGY equipment.





### SAR Drysuit

Energlo arms help for low or no light conditions. 400-denier TriTon fabric will hold up to years of abuse. Cordura® exterior material reinforces seat, elbows and knees for rugged protection in high-wear areas. Neoprene padding in the elbows and knees provide extra protection while working in the field. Liquid neoprene coating protects latex wrist and neck gaskets from UV rays. TriTon fabric socks. Internal suspenders. Self-draining thigh pocket and a splash proof arm pocket. Heavy-duty YKK® waterproof men's relief zipper and entry zipper seals out water. Neoprene outer cuffs with adjustable hook-and-loop closures on the neck, wrist and ankles protect the latex gaskets. Reflective material on the wrists and piping. Pull cord waist adjustment allows for a more custom fit.

2084225153	M/L
2084225155	XL/XXL

SAR Drysuit		
Size	Height	Weight
M/L	5'5" - 6'0"	130-195 lbs.
XL/XXL	5'10" - 6'4"	185-245 lbs.



### Swiftwater Rescue Drysuit

The Mustang Swift Water Rescue Dry Suit provides maximum protection without sacrificing the mobility and comfort required for long duration wear in adverse environments.

- Breathable GORE-TEX® reduces thermal stress
- Durable Kevlar® patches on legs and seat
- Adjustable neck seal and neoprene wrist seals
- Cushioned knees and elbows for protection
- Internal elastic suspender system
- Diagonal cross-chest waterproof entry zipper
- Waterproof relief zipper

204957520	Small
204957530	Medium
204957540	Large
204957550	XLarge
204957560	XXLarge

Swiftwater Technician Drysuit		
Size	Chest	Height
S	34-36	5'2" - 5'5"
M	37-40	5'5" - 5'9"
L	41-44	5'9" - 6'1"
XL	45-47	6'1" - 6'3"
XXL	48-51	6'3" - 6'6"
XXXL	52-55	6'6" - 6'8"

### Wavelite Union Suit

10 oz polyester/Spandex blend for a mid-weight insulating layer with excellent stretch. Soft terry liner and flat-stitched construction for comfort. Wear the Union Suit for a toasty, draft-free base layer under your drysuit. Double-pull zipper with protective inner flap. Specify size: XS - XXL.

208422552X	Union Suit
------------	------------



### Rescue Technician Deluxe Drysuit

*Ultimate In Rescuer Comfort*

Made from three ply waterproof/breathable laminate having a micro denier polyester exterior fabric, a Sympatex waterproof / breathable barrier membrane and a tricot fabric inside layer. SOLAS Reflective tape included on elbow pad above the wrist wraps. Diagonal entry #8 brass tooth zipper with zipper cover for guaranteed watertightness. Cordura Butt Pad, Knee Pads, and Wrist/Ankle Wraps for protection, strength and improved slip control. Color: Sea Rescue Orange.

23090602Z	Small
23090603Z	Medium
23090604Z	Large
23090605Z	XLarge
23090606Z	XXLarge

Rescue Technician Drysuit		
Size	Height	Weight
S	5'3" - 5'6"	115-135 lbs.
M	5'7" - 5'11"	135-160 lbs.
L	5'10" - 6'1"	165-200 lbs.
XL	6'1" - 6'3"	200-230 lbs.
XXL	6'2" - 6'4"	230-260 lbs.

**⚠ WARNING**

Technical rescue and safety is potentially hazardous. Any person using equipment sold by RESCUE TECHNOLOGY in any manner is personally responsible for learning the proper techniques involved, and assumes all risks and accepts full and complete responsibility for any and all damages or injury of any kind, including death, which may result from the use of any RESCUE TECHNOLOGY equipment.





### EXTREME Drysuit

It utilizes 420-denier 3-layer TriTon™ fabric, making it rugged, waterproof and highly breathable. Heavy-duty YKK waterproof zipper across the body, plus extra-tough latex wrist and neck gaskets. Reinforced Cordura® seat, elbows and knees. Neoprene outer cuffs with adjustable hook-and-loop closures on the neck, wrist and ankles help keep you warm and protect gaskets from tough use. Reflective arm strips and shock-cord waist adjustment. Relief Version is complete with Relief Zipper and TriTon Socks.

- 20842250X Extreme Drysuit, S-XL
- 208422506 Extreme Drysuit, XXL
- 20842251X Extreme Relief, S-XL
- 208422516 Extreme Relief, XXL



### Swift Entry Drysuit Basic Swiftwater Drysuit

A rugged dry suit at an economical price. This popular drysuit is now built with waterproof, breathable Tropos fabric. The Swift-Entry has an adjustable waistband to allow for custom fit. Neoprene cuffs over latex gaskets at wrists and ankles, plus reinforced knees and seat, ensure long life. YKK metal-tooth zipper. Sizes: S-XXL. Color: Cobalt/Black.

- 208422522 Small
- 208422523 Medium
- 208422524 Large
- 208422525 XLarge
- 208422526 XXLLarge

Swift Entry Drysuit		
Size	Height	Weight
S	5'2" - 5'6"	115-140 lbs.
M	5'6" - 6'0"	140-175 lbs.
L	5'10" - 6'2"	175-200 lbs.
XL	6'0" - 6'4"	200-240 lbs.
XXL	6'4" - 6'6"	220-260 lbs.



### Front Entry Drysuit Breathable GORETEX® Technology

3-Layer GORE-TEX® IMMERSION® Technology fabric is completely waterproof, breathable, and durable. Tightly woven fabric is tough as nails, yet quiet and comfortable. Color: Mango/Cobalt. Sizes S-XXL. For Rescue Tech by Kokotat. Specify Size.

Standard: Latex gaskets, neoprene trim, metal tooth waterproof zipper. 500 den Cordura seat and knee patches. Self-draining pockets.

Deluxe: adds Gore-Tex™ booties and relief zipper

- 2309011X Standard, S-XL
- 23090116 Standard, XXL
- 2309012X Deluxe, S-XL
- 23090126 Deluxe, XXL

Front Entry Drysuit		
Size	Height	Weight
S	5'2" - 5'6"	115-140 lbs.
M	5'6" - 6'0"	140-175 lbs.
L	5'10" - 6'2"	175-200 lbs.
XL	6'0" - 6'4"	200-240 lbs.
XXL	6'4" - 6'6"	220-260 lbs.



### Drysuit Undergarments

The next generation of next-to-the-skin layering garments. Made from anti-microbial fabric for warmth, comfort and breathability. These high performance pieces are designed to provide a comfortable, wicking first layer under clothing, drysuits, and wetsuits. Specify Size: S - XXL.

- 20842550X Pants, S, M, L, XL
- 208425506 Pants, XXL
- 20842551X Shirt, S, M, L, XL
- 208425516 Shirt, XXL

**⚠ WARNING**

Technical rescue and safety is potentially hazardous. Any person using equipment sold by RESCUE TECHNOLOGY in any manner is personally responsible for learning the proper techniques involved, and assumes all risks and accepts full and complete responsibility for any and all damages or injury of any kind, including death, which may result from the use of any RESCUE TECHNOLOGY equipment.





## Ice Commander Rescue Suit

The suit of choice for Coast Guard, SAR, Fire, and all Ice Rescue Professionals. Its Integral chest harness, ice awl pockets, gloves, reinforcements and non-slip soles keep you prepared for any emergency. Highly visible welded nylon shell and removable AirSoft™ foam liner. It's 45% lighter than conventional neoprene suits, giving maximum flexibility and performance. Size: Adult Universal. Body Mass: 110 - 330 lbs. Height: 4'11" - 6'7". Color: Yellow.

20499000	Ice Commander Rescue
20492001	Replacement Bag
2049228202	Replacement Liner
20492290	Repair Kit

## Cold Water Dive Hood

Cold water diving hood with bib. One of the most comfortable and best fitting hoods on the market. 6.5mm neoprene, 3mm skin-in face seal & 3mm Nylon II bib. Vent at top of hood releases excess air. Face area left unbound for custom trimming. Also available with zipper closure for easier donning and doffing. Specify Size.



23709241X	6.5mm
23709251X	6.5mm with Zipper

## Cool Water Dive Hood

1.5mm nylon II neoprene. Face area left unbound for custom trimming. Also available with zipper closure for easier donning and doffing. Specify Size.

23709221X	1.5mm Hood
-----------	------------



## 3mm Shorty

The little brother of our best selling Farmer John, the Shorty Wetsuit combines warmth and mobility for those warm weather, cold water days.

- 3mm neoprene retains core body heat and offers cushioning.
- Short-cut legs give increased freedom without sacrificing core warmth.
- Featuring a full-length, double-pull front zipper for ease of entry and relief.

208422173	Men's, Medium
208422174	Men's, Large
208422175	Men's, XLarge
208422176	Men's, XXXLarge
208422177	Men's, XXXLarge

208422161	Women's, XSmall
208422162	Women's, Small
208422163	Women's, Medium
208422164	Women's, Large
208422165	Women's, XLarge

20842217G3	Men's Grizzly, Medium
20842217G4	Men's Grizzly, Large
20842217G6	Men's Grizzly, XLarge
20842217G8	Men's Grizzly, XXXLarge



## 2mm Wetsuit Jacket

Combine the 2mm neoprene Wetsuit Jacket with any of our other wetsuits for maximum warmth in your arms and torso. The Grizzly Wetsuit Jacket gives the greater girth needed by the barrel-chested boater. Pair these items with matching Farmer John suits for the ultimate warmth and comfort. 2mm neoprene with Titanium laminate adhesive increases warmth without adding excess bulk. PowerSpan™ under the arms gives you plenty of mobility. The extended waist and raised collar give you superior coverage and increased warmth and comfort. YKK® wrist and full-front zippers provide easy, trouble-free entry.

208422103	Medium
208422104	Large
208422105	XLarge
208422106	XXLarge
208422107	XXXLarge

20842210G3	Grizzly, Medium
20842210G4	Grizzly, Large
20842210G6	Grizzly, XLarge
20842210G8	Grizzly, XXXLarge





### Grizzly Farmer Bill

Big folks know finding the right size in water gear can be a bear. The Grizzly wetsuit is extra roomy.

- Features 3-mm Neoprene for superior insulation.
- Cut large around the chest, waist, thighs and calves.
- Combines the convenience of a full-length front zipper with roomy, over-the-shoulder Farmer Bill-style suspenders.
- Color: All sizes are black - shoulders are color coded by size.

20842219G3	Medium	111.00
20842219G4	Large	111.00
20842219G6	XXLarge	111.00
22822219G7	XXXXLarge	111.00



### Farmer John / Farmer Jane

Just the essentials, at a great price. The same proven design as the 3mm Farmer John, but crafted with lighter 2.5-mm neoprene.

- 2.5-mm neoprene forms the base and is protectively backed with comfortable nylon on both sides.
- Large arm holes assure you full freedom of movement.
- Extra-long, double-pull YKK® front zipper for easy entry and relief.
- Armored seat and knees have reinforced padding for extra durability and protection.
- Zippered ankles make it easy to get over booties.

208422243	Mens, Medium
208422244	Mens, Large
208422245	Mens, XLarge
208422246	Mens, XXLarge
208422247	Mens, XXXLarge
208422248	Mens, XXXXLarge
208422251	Womens, XSmall
208422252	Womens, Small
208422253	Womens, Medium
208422254	Womens, Large
208422255	Womens, XLarge
208422256	Womens, XXLarge



### Standard Rescue Wetsuit Front Zipper

A full-coverage suit. 3 mm Dupont® neoprene provides insulation, while PowerSpan™ panels on the shoulders, back and arms increase mobility. Zippers on wrists and ankles for easy exit from the suit after a long day. Textured raw neoprene friction zones on the sides help lock a PFD in place. 5 mm seat for extra padding is covered with ToughTex™ for durability. Molded polyurethane knees and shins for long wear and extra protection. Reflective Lettering and Bright Yellow Panels Color: Yellow/Black. Grizzly Version provides extra room in the chest and waist area.

208422132	Small
208422133	Medium
208422134	Large
208422135	XLarge
208422136	XXLarge
208422137	XXXLarge
20842213G4	Grizzly Large
20842213G6	Grizzly XXLarge



### Seal Skinz Socks

A three-layer, waterproof and breathable sock that fits perfectly under any river shoe or sandal. Specify Size: S-XL.

20842350X Seal Skinz Sock

#### Women's Wetsuit Sizing - Standard

Size	Height	Weight
XS	4'8" - 5'2"	90-115 lbs.
S	5'1" - 5'6"	110-135 lbs.
M	5'5" - 5'8"	130-155 lbs.
L	5'7" - 5'10"	150-180 lbs.
XL	5'9" - 6'0"	175-210 lbs.
XXL	5'11" - 6'2"	200-220 lbs.

#### Men's Wetsuit Sizing - Standard

Size	Height	Weight
S	5'2" - 5'6"	115-140 lbs.
M	5'5" - 5'8"	135-165 lbs.
L	5'7" - 6'0"	150-195 lbs.
XL	5'10" - 6'2"	185-225 lbs.
XXL	6'1" - 6'4"	215-245 lbs.
XXXL	6'3" - 6'5"	230-255 lbs.
XXXXL	6'4" - 6'6"	245+

#### Wetsuit Sizing - Grizzly

Size	Height	Weight
G-Med	5'5" - 5'9"	200-235 lbs.
G-Large	5'8" - 6'0"	230-265 lbs.
G-XXL	5'11" - 6'4"	260-305 lbs.
G-XXXXL	6'3" - 6'6"	275-320 lbs.

## ⚠ WARNING

Technical rescue and safety is potentially hazardous. Any person using equipment sold by RESCUE TECHNOLOGY in any manner is personally responsible for learning the proper techniques involved, and assumes all risks and accepts full and complete responsibility for any and all damages or injury of any kind, including death, which may result from the use of any RESCUE TECHNOLOGY equipment.





**Mustang Classic Inflatable PFD**

*Reliability with T-Shirt comfort.*

Compact design lays flat against chest for freedom of movement. Durable 420 denier Outer shell, 35 lbs of buoyancy. Includes Safety Whistle, SOLAS reflective tape. When inflated is capable of self-righting a face down person. Available with manual activation or manual with automatic backup. Auto-inflation system activates in contact with water. Universal size Age: 16 years and up. Weight: 80 lbs and up. Color: Navy. USCG Type V

204930034	Airforce Inflatable PFD(RD)
204930036	Airforce Inflatable PFD(BL)
20497170	Re-Arm Kit for Airforce
204930314	Airforce with Auto backup (RD)
204930316	Airforce with Auto backup (BL)
20497172	Re-Arm Kit for Auto-inflate



**Mustang HIT Inflatable PFD**

*Hydrostatic Auto-Inflation*

For severe weather, no premature inflation, low maintenance. The Auto Hydrostatic Inflatable Personal Flotation Device (PFD) will only automatically inflate when submerged in 4 or more inches of water and not prematurely due to rain, spray or humidity. No inflator maintenance is required for 5 years unless the PFD has been inflated. Inflator status and replacement date viewed through the safety inspection window. Made for the most demanding users, constructed of durable 420-Denier nylon and heavy duty polyurethane coated nylon. Lightweight and comfortable, the PFD can be worn over a T-shirt or jacket. It is low profile and allows for the maximum amount of mobility. The neoprene Comfort Collar™ is so soft it won't chafe your neck. USCG Type V.

204931834	HIT, Red/Black
204931831	HIT, Charcoal/Black
20497214	HIT Re-Arm Kit



**Force 6 Rescuer Vest**

This IRIA Certified rescue vest is made of rugged, high visibility rip stop nylon and contain extra flotation to combat the reduced buoyancy effects of turbulent water.

- M/L vest provides 28 lbs of buoyancy
- XL vest provides 32 lbs of buoyancy
- Integrated structural harness
- Polymer panels for impact protection
- "Live bait" quick release
- Fast Tabs on both shoulders for easy attachment of accessories such as knives, scissors or strobe lights
- Reflective tape over the shoulders and on both pockets
- Two quick-drain front pockets
- One piece over the shoulder foam provides extra strength, structural integrity and body protection
- Three-part waistbelt for fit
- IRIA certified
- Transport Canada approved to CAN/CGSB 65.11-M88

20491003	M/L	215.00
20491005	XL	215.00

**▲ WARNING**  
 Technical rescue and safety is potentially hazardous. Any person using equipment sold by RESCUE TECHNOLOGY in any manner is personally responsible for learning the proper techniques involved, and assumes all risks and accepts full and complete responsibility for any and all damages or injury of any kind, including death, which may result from the use of any RESCUE TECHNOLOGY equipment.

**Force 6 Instructor Vest**

Force 6 has taken their Rescuer Vest 1-step further by adding features needed by instructors. In addition to the long list of of Force 6 Rescue Vest specifications, the Instructor Vest includes: Removable front and back pockets and Extrication leash (cowtail).

20492003	M/L 275.00
20492005	XL 275.00





Rear "D" Ring

## Universal Rescuer

*Universal Sizing fits 30 - 56" Chest*

Features over-the-shoulder integral webbing reinforcement, a USCG approved rescuer's harness, and reflective tape on the shoulders and across the back. Design Flotation: 23 lbs.

350632 Yellow  
350634 Red

USCG Approved, UL Listed Type V PFD



Rear "D" Ring

## Swiftwater Fury

Highest flotation available in a short PFD, with ultra-soft foam for remarkable comfort and mobility. Designed for rescue units that need its unique combination of high buoyancy and short length. Features a loop strip over the shoulder to attach various accessories. Quick-release belt. Design Flotation: 22 lbs. - 22 lbs. 13 oz. Specify Size: S, M, L, XL.

3502X2 Yellow  
3502X4 Red

USCG Approved, UL Listed Type V PFD.



Rear "D" Ring

## Swiftwater Ranger

The most buoyancy available in a rescue PFD. Its high back, padded shoulders, and long length offer exceptional protection when swimming rapids. THE choice of swiftwater rescue teams nationwide. Quick-release belt. Design Flotation: 24 lbs. 7 oz. - 26 lbs. 12 oz. Specify Size: S, M, L, XL.

3503X2 Yellow  
3503X4 Red

USCG Approved, UL Listed Type V PFD.

SIZE	Fury	Ranger
Small	37 - 39"	36 - 39"
Medium	40 - 42"	40 - 44"
Large	43 - 45"	45 - 49"
XLarge	46 - 48"	48 - 52"



## U22 Agency Pro

*Universal Size high flotation vest*

The U22 fits chest sizes from 30 - 56 inches. Its generous divided side pockets, external D-rings, and lash tabs allow attachment of multiple accessories. A 3 buckle closure system, generous reflective tape and 8 adjustment points create an excellent high-flotation option for water rescue and support teams. Design Flotation: 23 lbs.

350732 Yellow  
350734 Red

USCG Approved, UL Listed Type III PFD



## NRS Rapid Rescuer

Type III/V PFD. With 22 lbs of flotation, adjustability to fit chest sizes from 30 to 58 inches, and all the features you will ever need in a rescue vest. Two huge front pockets stretch to hold anything you need to keep handy. A D-ring, strobe holder, and tether attachment round out the attachment points on the front with a safety light stick holder on the back and reflective tape everywhere. 8 adjustment points to ensure a secure fit.

208421494 Red  
208421492 Yellow



## Water Rescue Tow Tether

Constructed of Heavy Duty Tubular Webbing, elastic, and steel ring. One end has a 2" ring to attach to the waist strap of Rescue PFD's. The other end is attached to a lightweight non-locking aluminum carabiner.

351101 Short Tether (35" Max)  
351105 Long Tether (54" Max)





## Cascade Water Rescue Helmet

Multiple impact polypropylene, patented liner system. Closed cell foam won't absorb moisture. 4 point chin strap. 13 ventilation / drain ports. Stainless Steel hardware. Colors: Red, Yellow, White. Specify Color.

48042X	Small	(21.6 - 22.25")
48043X	Medium	(22.5 - 23")
48044X	Large	(23.25" - 23.75")
48045X	XLarge	(23.75" - 24")
48046X	XXLarge	(25" - 26")

480499	Reflect. 'RESCUE' Crescent
480498	Reflect. 'WATER RESCUE' Crescent



## Protec Full Cut Water Rescue Helmet

Ideal for water rescue and water sports. Durable, extruded plastic shell. Closed cell, replaceable liner designed to drain quickly after immersion. Wrap-around design protects skull, temple area, and base of neck. Weight: 14 oz. Colors: Red, Yellow, Black. Specify Color.

480603X	Small/Medium	(20 7/8 - 22 7/8")
480604X	Large/XLarge	(22 1/2 - 24 1/2")



## Protec Ace Water Rescue Helmet *Cutting Edge Design*

Features innovative pad inserts to create a top-notch swiftwater rescue helmet. Pad can be adjusted to fit a wide range of sizes. Cut over the ear for unrestricted hearing and comfort, while maintaining excellent brow and temple coverage. Colors: Red, Yellow, Fluorescent Yellow, Black. Specify Color.

480662X	Small (20 1/8 - 20 7/8")
480663X	Medium (21 1/4 - 22")
480664X	Large (22 3/8 - 23 1/8")
480665X	XLarge (23 1/2 - 24 1/4")



## Helmet Liner

Much of your body heat escapes through the top of your head. Protect yourself with the NRS Mystery Side Cut Helmet Liner. Under your helmet this liner will keep you warm and comfortable. 1mm of neoprene provides the core insulation for this helmet liner. The GlideSkin™ exterior reduces evaporative cooling, increasing heat retention. Titanium laminate adhesive reflects and retains body heat for superior warmth. Lined with soft ThermalPlush™ fabric for all-day comfort.

20842026	Full Cut
20842027	Side Cut



## ProTec Wake Helmet

High-density polyethylene shell for durability, and dual density foam lining for multiple-impact protection. Features a support piece for the back of the head, which also gives you a better customized fit. Attachable, low-profile perforated ear pads give extra protection and warmth without impeding hearing. Certified to EN 1385 CE helmet standards. Specify Color: Black, Yellow, Red, Blue

208420312X	Small	(20 1/8 - 20 7/8")
208420313X	Medium	(21 1/4 - 22")
208420314X	Large	(22 3/8 - 23 1/8")
208420315X	XLarge	(23 1/2 - 24 1/4")



## WR7 Water Rescue Helmet w/ Vents

New Kiwi Helmet with adjustable vents to let heat and water out.

481574	Red
481572	Yellow
481579	White





### First Responder Water Rescue Set

Includes equipment most often required for swiftwater rescue classes. Set includes: Universal Rescuer PFD, Protec Helmet, Swiftwater Team Member Boots, 2mm Dive Glove, Throwbag -70', Fox 40 Rescue Whistle, River Rescue Short Knife. Deluxe Set includes Water Rescue Team Member Bag (p/n 807542 ) and Shredder Fins.

- |          |                |
|----------|----------------|
| 29982001 | Standard       |
| 29982002 | Deluxe (Shown) |



Equipment not included

### Water Rescue Team Member Bag

A new, versatile bag for both Surface and Dive Rescue Team Members. Manufactured with side panels of strong Vinyl Coated Nylon mesh, this bag allows for excellent content ventilation. Front panel, zippered mesh-backed pockets hold fins, gloves, snorkels, and other personal gear. Interior compartment is large enough to hold Drysuit, PFD, helmet, Boots, and throw bag. Side compression straps. Top handle and Shoulder Strap D rings. Dimensions: 26" x 18" x 10".

- |        |                        |
|--------|------------------------|
| 807542 | Rescue Team Member Bag |
| 809790 | Padded Shoulder Strap  |



Equipment not included

### Swiftwater Team Member Duffel

A tough, heavy-duty duffel. Sturdy 600 denier polyester forms the bottom and ends of the bag to protect your gear from sand and grit, and will endure years of abuse. High-strength mesh allows wet gear to dry, reducing mildew other moisture-related problems. Color: Blue.

- |        |                    |
|--------|--------------------|
| 807241 | Large (30" x 16")  |
| 807231 | Medium (24" x 12") |



### Heavy-Duty Dry Bag

The standard in heavy duty, large dry bags. Now with the most comfortable shoulder straps ever. PVC/polyester body plus a 34 oz. bottom panel extending 3" up the sides for incomparable durability. Size: 33"H x 16" dia. Color: Red.

- |          |              |
|----------|--------------|
| 20842903 | H.D. Dry Bag |
|----------|--------------|



### Dry Bag

Tough 21 oz. PVC fabric makes this bag the ideal storage system for rescue equipment. Bag handle and straps are welded to the bag with a heavy-duty double patch system. StormStrip Closure ensures the most waterproof seal on the market. Dimensions: 25" x 14".

- |           |                  |
|-----------|------------------|
| 208429106 | Dry Bag (Blue)   |
| 208429102 | Dry Bag (Yellow) |
| 208429104 | Dry Bag (Red)    |





### Rescue Wetshoe

Simple, sturdy, dependable. 5mm comfort insole and 2mm plastic midsole. Zippered entry. Manufactured from 3mm neoprene. Sole is wrapped with heavy duty traction pad. Toe and heel cup offer extra protection. Sizes: 4 - 15 (whole sizes only, 1/2 sizes order next larger size). Color: Black. Specify Size.

20842310-XX	Size 4 - 13
20842310-14	Size 14
20842310-15	Size 15



### ATB Dive / Rescue Boot

All Terrain Bootie combines the comfort of a sneaker with the warmth of a wetshoe. Full molded, arched sole is reinforced with a 2mm plastic midsole shim to increase stability and comfort. 7mm neoprene cushion insoles and 5mm uppers with glued and blind-stitched seams. Heel and toe caps protect from abrasion. Zippered opening. Sizes 6 - 13 (whole sizes only, 1/2 sizes order next larger size) Color: Black/ Gray

20842335-XX ATB Dive / Rescue Boot



### Swiftwater Team Member Workboot

Used by rescue groups and Navy SEALs. 3mm Nylon II neoprene sock. Rubber outsole and EVA midsole with super-grip sole. Brushed rubber toe and heel cap with synthetic leather upper. Parachute 550 cord boot lace and Velcro® cinch strap. Water purge at instep protected by screened metal eyelet. A definite improvement over "Tennis-Shoe" sole workboot design. Whole Sizes: 7 - 15.

23709375-XX Swiftwater Team Workboot



### Water Tech Rescue Glove

Developed for rescue professionals who spend most of their working hours handling rope and rigging systems. Aramid fiber patches on the palm and fingers for superior durability. Padded knuckles and back protect hands. 2mm neoprene back maximizes warmth, while synthetic leather palms limits slip and enhances dexterity. Wrist openings cinch with elastic hook and loop band. Specify Size: S, M, L, XL, XXL.

20842439X Water Tech Glove



### Warm Water Dive / Rescue Glove

1.5mm short cuff neoprene glove stretches to keep you in touch with your equipment. Durable GripCote™ palm ensures a solid grip and improved performance. Wristband helps seal our water. Specify Size: XS, S, M, L, XL, XXL.

20842417X Warm Water Glove



### Lightweight Water Rescue Glove

Lightweight, durable glove for all rescuers. 2mm Neoprene on back for lightweight comfort & protection. Palm and fingers of reinforced Amara for durability. Stretch elastic band with Velcro closure. Specify Size: XS, S, M, L, XL, XXL.

23709341X Lightweight Water Glove

## ▲ WARNING

Technical rescue and safety is potentially hazardous. Any person using equipment sold by RESCUE TECHNOLOGY in any manner is personally responsible for learning the proper techniques involved, and assumes all risks and accepts full and complete responsibility for any and all damages or injury of any kind, including death, which may result from the use of any RESCUE TECHNOLOGY equipment.



**Rocket Fin**  
**Quick-Release Strap**

One of the first vented rubber fins available. Traditional all rubber design. Popular with military and professional divers.



2370621110



**Shredder Rescue Fins**  
**Fits over Swiftwater Rescue Boots**

Ultra-Light technopolymer optimizes power with up to 50% less weight and bulk. Blade design improves thrust and reduces ankle and leg fatigue. Adjustable buckle with quick-release system secures fins even in swiftwater. Designed to fit all large dive / rescue style boots.

46005342	Yellow/Black
46005341	Black
46005349	Replacement Strap



**Universal Rescue Fins**

Designed to meet the demands of swiftwater rescue professionals, the Universal Swim Fins also work well for riverboarding and general river snorkeling. These rigid fins are symmetrical so they fit either foot. The wide heel strap is adjustable with a quick tug of the strap end, then you can unclip the strap and your adjustment stays put. The toe piece has a removable rigid insert that lets you select the stiffness you desire. The fins will fit over your river boots - just step in, click in the heel strap and you're ready to go!

20841897

**Inflatable Rescue Board**

The NRS Inflatable Rescue Board meets the tough demands of the swiftwater rescuer. Lightweight, stowable, versatile - it's built to last.

- Inflatable design is easy to stow and transport into the field.
- Top is made of rugged 840-denier urethane coated nylon for durability.
- Reinforced PVC bottom is slick and abrasion resistant. Sculpted design aids control and wave riding.
- Two inflated "skegs" add directional stability and control.
- The durable urethane bladder is inflated with a top quality Leaffield C-7 Valve.
- Two sets of heavy-duty handles assist the rescuer and victim.
- The 3" D-ring attachment on the nose is massively reinforced to take the strain of towing and lowering.
- Bright colors and large "RESCUE" lettering improve rescuer's visibility.
- Board is 30" W x 58" L

20841868 Inflatable Rescue Board



**LifeSled®**  
**PWC Towable Rescue Board**

Designed for Ocean, Swiftwater and Ice Rescue where a towed board is essential. Severe-duty 3-point non-invasive hookup system with replaceable components. Over 450 lbs. of deadweight buoyancy. Ten fiber reinforced, tacky-when-wet handles are anchored internally. Stows "folded-over" PWC when not in use. Dimensions: 62" x 36" x 4.52". Weight 38 lbs.

351511	LifeSled
351503	Rescue Sled Storage Bag

**Carlson Rescue Board**  
**Lightweight & Maneuverable**

For recreation or rescue. Solid Ethafoam with a slick bottom for performance and durability. (3-year warranty against delamination) Oversize Shipping Charges Apply. Color: Black

20841870 Carlson Rescue Board





### Ring Buoy USCG Approved

Unicell soft foam. Won't rot or water log. Diameter: 24". Complete with grab lines. Color: Orange.

460008	Ring Buoy, 24"
460008-060	w/ 60 ft. Tether
460008-100	w/ 100 ft. Tether
460008M	Ring Holder



### Rescue Tube

Yellow vinyl coating for great visibility and lightweight foam body for handling comfort. 3" x 36" with soft, nylon rope and one-piece body belt. USCG approved bronze snap hook.

460001	Rescue Tube, 40"
--------	------------------



### Rescue Can

Features hand grips that are secure and comfortable to grasp and help to calm a panicky swimmer. High visibility Bright Day-glow Orange color. Dimensions: 27.5 x 8.5 x 6". Weight: 4 lbs.

460005	Rescue Can
460006	Rescue Can, Max Flotation
460005R	Rescue Can Rack
460006R	Rescue Can Rack, Max Float

**⚠ WARNING**

Technical rescue and safety is potentially hazardous. Any person using equipment sold by RESCUE TECHNOLOGY in any manner is personally responsible for learning the proper techniques involved, and assumes all risks and accepts full and complete responsibility for any and all damages or injury of any kind, including death, which may result from the use of any RESCUE TECHNOLOGY equipment.

### LSP Cinch Collar

Easy to use - The victim simply enters the harness with head and arms extended before tension is applied by the rescuer. The victim's weight will release the connector and allow the collar to cinch around him, preventing him from slipping out in the event he becomes unconscious. Durable-The interior of the Cinch is a non-absorbent, closed-cell foam. The outer covering consists of a tough, stain-resistant, washable Cordura which provides protection and comfort to the victim.



21542010	LSP Cinch
----------	-----------

### Zipper Lubricant

Lubricates and prolongs the life of zippers on wetsuits, drysuits and booties.



20842288	Zip Tech
----------	----------

### Ice Anchor

*Super Corrosion Resistant*

Plated CrMo tubes with high strength hangers are the ideal anchor tool for Ice Rescue. Speed Grinder knob system makes placing these screws a breeze.

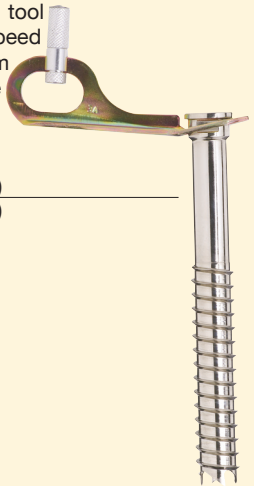

46001917	6.8" (17 cm)
46001922	8.8" (22 cm)

### Wetsuit Shampoo

Complete, scientifically balanced maintenance system for all neoprene and sports gear. Ideal for wetsuits, drysuits, boots, gloves, fishing waders, orthopedic supports, lycra body suits and more. Leaves neoprene articles free of organic residue, chlorine and salt deposits. Chlorine-removing agents and conditioners help prevent premature aging and oxidation.



20842249	Gallon
20842248	8 oz.

### Zipper Care

Zip Care is the ultimate zipper care for plastic, nylon or metal zippers. Unique push-pull brush top enables the cleaner to be delivered between the teeth and physically removes harmful dirt, sand, and salt deposits that can jam the zipper. Cleans drysuits and wetsuit zippers. Mild lubricant without silicone.



20842290	Zipper Care
----------	-------------





### Dive Mask Training Blackout Cover

Finally, a reusable Diving Mask Cover that works. Made from tough, coated nylon fabric and elastic drawstring adjuster. Can be easily removed in an emergency situation. Excellent access to nose cup for clearing ears.

460101 Mask Blackout Cover



### Maui Dive Mask

Low volume, single window design. Black Silicone Skirt. Popular Mask for military and Professional divers.

2370503350



### Seal Swim Mask

This is the mask that revolutionized the water industry by adding fit, functionality, and comfort to aquatic eyewear. Patented curved lens provides 180-degree peripheral vision without distortion. Dive quality silicone skirt provides a comfortable watertight fit. 100% UVA and UVB protection.

46010201	Clear Lens
46010209	Photochromic Lens

### Sea Gold Anti Fog Gel

Rated BEST Anti-Fog by Rodale's SCUBA DIVING Magazine! The clear choice in anti-fog gels. Our unique clear formula means long lasting anti-fog protection. Sea Gold is highly concentrated and designed for quick, simple, in-field application. Sea Gold is safe for all glass and plastic lenses and will not harm surrounding silicone or rubber support frames. Not recommended for swim goggles.



238140851 Sea Gold, 1.25 fl. oz.

### Military Flex Snorkel

Classic neoprene rubber design with flex tube. Used by military units worldwide for its versatility and performance. Ideal for rescue and recover dive teams. Includes keeper for mask strap.



23706930

### Impulse 3 Flex Snorkel

Improved and streamlined. Patented Impulse Dry™ valve stops water from entering the snorkel. Large bore contoured barrel for unrestricted breathing. Self-draining purge valve for use when switching from scuba to snorkel. Pure soft silicone patented Comfo-Bite™ mouthpiece. Includes snorkel keeper.



4601053 Impulse 3 Snorkel



### Aquaseal Wetsuit Repair Adhesive

The industry standard for maximum strength repairs to wetsuits, dry suits and all water sports products. Flexible urethane formula waterproofs, seals and protects against abrasion. Hundreds of water sports and household uses. Flexible Urethane formula that waterproofs, seals and protects against abrasion.

2282572 Aquaseal, 1 oz. Tube

Flammable - UPS ground only.



### Training Aids

Rescue Diver training aid requirement. Solid rubber. For pool skills training for divers. 5" Donut rings may be used for assorted training exercises.

4600161	Block, 10 lb. (each)
4600162	Donut, 5" (each)



### Ankle Weights For Use with Drysuits

Fully adjustable length with quick-release buckle for safety. Neoprene. Sold in pairs. Color: Black

4600153 3 lbs., Pair





**River Rescue Short Knife**

Features quality 420 Stainless Steel 3" blade with serrated top edge for rope cutting, blunt chisel tip and line cutter. Molded Grip and sheath. Blade Shank protrudes past handle end to allow use as striking tool. Dimensions: 6.75 x 1.25" Weight: 4 oz.

6301200	Orange
6301202	Yellow
6301201	Black (not shown)



**Dive Rescue Shears**  
*Great for Rescue Diver Safety*

EMT Shears in a Pouch that secures to BC Shoulder Strap or autoinflator hose. Includes Stainless Steel 7.5" EMT shears and adjustable pouch.

630111	Dive Rescue Shears
--------	--------------------

**⚠ WARNING**

Technical rescue and safety is potentially hazardous. Any person using equipment sold by RESCUE TECHNOLOGY in any manner is personally responsible for learning the proper techniques involved, and assumes all risks and accepts full and complete responsibility for any and all damages or injury of any kind, including death, which may result from the use of any RESCUE TECHNOLOGY equipment.

**Blue Tang Dive Knife**



The Blue Tang is a full size, rugged, multifunctional knife designed to meet the basic needs of every diver. Features Power Grip, hooked edge line cutter, 5 inch hollow ground double edge blade. Blunt tip and Steel end cap makes the Blue Tang the perfect work tool for Dive/Rescue. Dimensions: 9.5 x 2.2". Weight: 9 oz. Color: Black/Yellow.

630125	Blunt Tip
630126	Drop Point

**Fusilier Rescue / Dive Knife**

This full feature knife is the perfect knife for rescuer/divers who do not want to carry a big knife. It is small, lightweight and designed to fit every diving style. Features: Power Grip, Serrated Edge, Hooked Edge 4 inch double edge hollow ground blade, One Hand insertion and removal. Dimensions: 8 x 1.7". Weight: 6 oz. Color: Black/Yellow.

630122	Fusilier Rescue / Dive Knife
--------	------------------------------



**Squeeze Lock Knife**

A classic dive knife. Blade made from 304 stainless steel or high grade Beta Alloy Titanium. Patented Locking mechanism securely locks knife in sheath, but releases easily with a squeeze of the handle. Included mounting components allow the knife to be mounted to grommets, hose straps, or belt. Sheath has molded strap slots for use hose mounting straps. Length: 6.5" Overall; 3" Blade.

a. 23704752	Stainless Steel Blunt Tip
b. 23704852	Titanium Tanto Tip



**Pilot Knife**

Rescue professionals will really love the features of the Pilot Knife. Features both smooth and serrated sections plus a rope cutting hook. The blunt tip design protects against unintentional punctures! The unique sheath firmly locks the knife in place and only lets it go when you squeeze both sides of the release. Contoured handle and rubberized grip. Clip on sheath attaches firmly to PFD lash tab. Built in glass breaking tip on the end of handle. Length: 7.25" Overall; 3" Blade.

208427550	Orange
208427551	Black



## Super Hanger

Useful and economical for hanging a variety of dive equipment.  
Dimensions: 9" x 16.6 x 1.2".

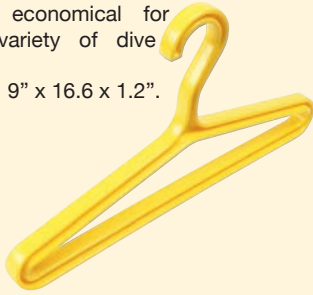

460012 Super Hanger



Lanyard Not Included

## FOX Whistle

One of the loudest whistles available. "Pea-less" design functions when wet - even under water. Color: Orange, Yellow.

2282465X	Fox 40 Whistle
2282464X	Fox Mini Whistle
2282469X	Fox 40 w/ Coil
2282468X	Fox Mini w/ Coil

## Super B.C. Hanger

Keeps Expensive equipment off the floor for proper drying and storage. Supports up to 20 lbs. Dimensions: 10" x 16" x 1.2".

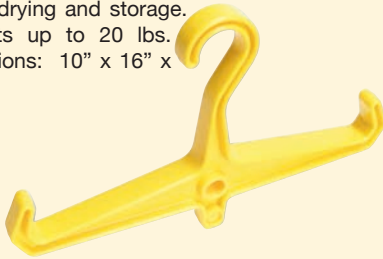

460010 Super B.C. Hanger



## Dive Rescue Search Line

Special 6mm Search Rope reduces resistance and drag as diver works search pattern. Kernmantle design virtually eliminates kinking found in monofilament "tow-line" braid. High quality bag carries 200 ft. of search line. 6mm Rope Strength: 600 lbf.; 8mm NFPA Throwline Rope Strength: 3,699 lbf.

460022	6mm, 200'
460122	8mm, 200'

## Super Accessory Hanger



Ideal for drying and storing gloves, booties and hood. Dimensions: 13" x 20" x 1.2".

460011 Super Accessory Hanger



## AquaStrobe™

Ultra-compact strobe that can be attached using a velcro closure strap or adjustable lanyard. Waterproof to 2000 ft. Operates 8 hours on one AA-cell Battery. Includes battery, lanyard and strap. Up to 70 flashes per minute. Weight: 3.4 oz.

488301 AquaStrobe

## Waterproof Radio Pouch

**Waterproof to 30 ft.**

Total watertight protection, effectively and inexpensively, to hand-held VHF/UHF radios. Waterproofs your radio in seconds. Will float with radio inside. No loss of signal. Salt-water proof. UV-Stabilized. Operating temperatures: -25°C to +90°C. Complies with SOLAS.

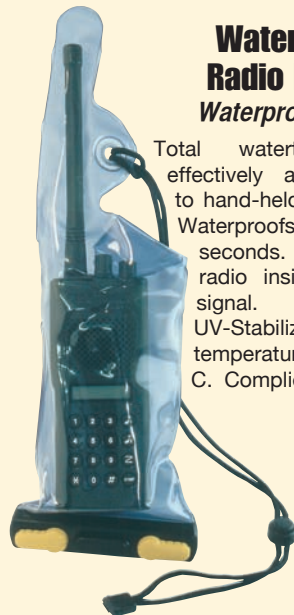

811139	Standard	13 x 3.9 x 6.9"
811149	Large	15.7 x 5 x 7.9"



## Pelican Float Marker Recovery System

Reusable Buoy made of structural foamed resin. Includes over 100 ft. polyethylene 225 lbs. test line. Includes 6 oz. non-drag dispatchable anchor. Color: High-visibility yellow with day-glow rings. Weight: 16 oz.

460020 Pelican Float

## Drysuit / Exposure Suit Hanger

Wide 4.5" hanger "arms" for ultimate protection of expensive Drysuits and Exposure suits. Dimensions: 15" x 16" x 4.5".



460013 Drysuit Hanger



## RescueTECH Throw Bags

*Complete with Throwline and Ready to Use*

Our Water Rescue Throwbags have been completely redesigned to give more features and make them easier to use. All bags utilize our Progressive Sewing Technology to give greater strength and resistance to abrasion. All ropes float - even when wet.

All of our bags feature:

- Double Stitched Seams
- Reinforced Bottom Seams
- Quick-Adjust Bucket Handle
- Drawstring with Durable Cord-Lock
- Drainage Grommets

### Standard Water Rescue Throw Bag

Standard bags are manufactured with a urethane-coated 400 Denier water-resistant nylon for superior abrasion resistance.

	Description	Length	Strength	Rating	Weight
598301050	3/8" Pro-Poly	50'	2960 lbf.	Throwline	2.5 lbs.
598301070	3/8" Pro-Poly	70'	2960 lbf.	Throwline	3.5 lbs.
598301100	3/8" Pro-Poly	100'	2960 lbf.	Throwline	4.5 lbs.
598302035	3/8" Standard Poly	35'	1900 lbf.		1.0 lbs.
598302050	3/8" Standard Poly	50'	1900 lbf.		1.25 lbs.
598302070	3/8" Standard Poly	70'	1900 lbf.		2.0 lbs.
598302100	3/8" Standard Poly	100'	1900 lbf.		3.0 lbs.
598303050	8mm NFPA	50'	2700 lbf.	Throwline	1.2 lbs.
598303070	8mm NFPA	70'	2700 lbf.	Throwline	1.7 lbs.
598303100	8mm NFPA	100'	2700 lbf.	Throwline	2.1 lbs.



### Deluxe Water Rescue Throw Bag

The Technical bags give the rescuer a top of the line throwbag. Manufactured of 1000 denier Cordura in the bottom end and 400 denier in the sides and open end. The "Tech" bag also features Reflexite retro-reflective trim and elastic lightstick holders.

	Description	Length	Strength	Rating	Weight
598311050	3/8" Pro-Poly	50'	3500 lbf.	Throwline	2.5 lbs.
598311070	3/8" Pro-Poly	70'	3500 lbf.	Throwline	3.5 lbs.
598312035	3/8" Standard Poly	35'	1900 lbf.		1.0 lbs.
598312050	3/8" Standard Poly	50'	1900 lbf.		1.25 lbs.
598312070	3/8" Standard Poly	70'	1900 lbf.		2.0 lbs.
598313050	8mm NFPA	50'	2700 lbf.	Throwline	1.2 lbs.
598313070	8mm NFPA	70'	2700 lbf.	Throwline	.7 lbs.



Tech Bags Include Reflexite™ retro-reflective stripes, Grab handles and Lightstick holders. (Lightstick not included.)

## RESCUE STICK

*Throwable Emergency Rescue Inflatable*

Incredibly easy to use, the Rescue Stick™ provides rapid flotation assistance to a person at risk of drowning. Simply remove the baton shaped Rescue Stick™ from its waterproof bag and throw near the person. Once contact is made with the water it inflates in seconds to a large horseshoe shape keeping them afloat and their head above water until help arrives. Measuring only 14" in length and weighing 15.5 oz., the Rescue Stick™ is the most versatile rescue flotation device available. Easily stowed in a boat, vehicle, backpack or by the pool it will be accessible when and where you need it. The Rescue Stick™ is an invaluable tool for first responders to provide emergency flotation when no water rescue gear is available.



2049101	Rescue Stick
2049103	Rescue Stick, Training Model
2049105	Rescue Stick Rearm Kit

## Pro-Poly™ Water Rescue Rope

100% Polypropylene

Kernmantle construction. Smooth sheath construction. Used in our Water Rescue Throwbags. Floats on top of water. Not recommended for rappelling or other heavy uses. Color: Yellow w/ Red & Blue Stripes



## 7/16" Water Rescue Rope

Nylon / Polypropylene

A special hybrid filament water rescue rope. Manufactured with a durable nylon sheath and a Multi-Filament Polypropylene core, this floating rope has a tensile strength of 5,000 lbf. Color: Yellow w/ Red Stripes and Yellow w/ Blue Stripes

## 8mm NFPA Throwline

Polypropylene / Dyneema

UL Certified to NFPA 1983. Double braid construction of high strength core fibers covered in polypropylene to create a floating rope that meets the required strength specifications. Bright Yellow Color w/ Red Stripes.

## 3/8" Standard Poly Throwline

100% Polypropylene

A throwline that gives rescuers an economic choice from the high-tech lines. Soft and easy to stuff and throw. 100% polypropylene solid braid.

Stock Number	Description	Dia. (in.)	Strength (lbf.)	Color	Wgt. per 100 ft. (lbf.)	Rescue Rope Rating
a. 516600	Pro-Poly	3/8	2,960	Yellow w/ Red/Blue	3.5	Throwline
b. 516700	Pro-Poly	1/2	3,400	Yellow w/ Red/Blue	4.2	Throwline
c. 50517000YR	Water Rescue	7/16	5,000	Yellow w/ Red	5.4	Throwline
d. 50517000YB	Water Rescue	7/16	5,000	Yellow w/ Blue	5.4	Throwline
e. 50528000	NFPA Throw	5/16	4,000	Yellow w/ Red	1.9	Throwline
f. 230327000	Standard Poly	3/8	1,900	Yellow/Red	2.5	



### Line Reel

Reel features lightweight, maintenance-free pvc pipe, a clutch to lessen backlash, removable handle, floating line, neck strap, and stainless steel snap. Line Diameter: 1/4".

460260	600 ft. line	18 lbs.
460280	800 ft. line	20 lbs.

### Water Rescue Jaws

With Water Rescue Jaws, you can:

- Probe in deep water with the 18 foot telescoping pole.
- Search effectively in open water.
- Search effectively in muddy water.
- Search through ice.
- Search through slow currents.
- Retrieve a victim without the threat of puncturing skin.
- Store easily in a 24" by 72" area.

2414103



### Pick of Life Ice Awls

Pick-of-Life awls are for self-rescue, allowing you to crawl on top of the ice using the picks as traction. You can also slide them to someone who has fallen through the ice.

208422459

RESCUE TECH

www.rescuetechn1.com



## CON-SPACE Communications Systems

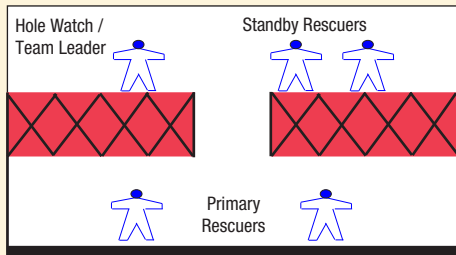

### Rescue Comm Kit 1

Configured for a team of five rescuers consisting of two primary entrants, two standby entrants and a safety attendant. Includes 100' of cable for each entrant (expandable to 1500 ft.). System can be configured for up to ten people using available modules and accessories. Weight: 49 lbs.

304011P Rescue Kit 1, Power Talk

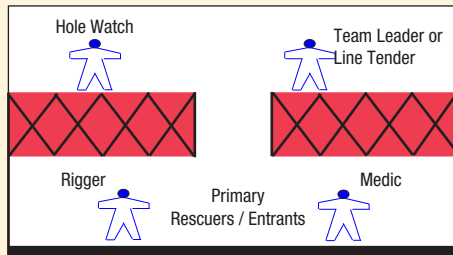

### Rescue Comm Kit 2

Configured for a team of four people consisting of two entrants, a safety attendant and a team leader. Includes 100' of cable for two entrants (expandable to 1500 ft.). System can be configured for up to ten people using available modules and accessories. Weight: 40 lbs.

304012 Con-Space Rescue Kit 2

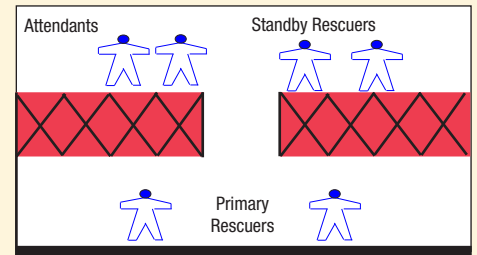
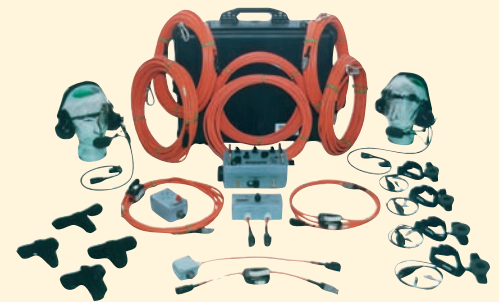

### Rescue Comm Kit 5

Configured for a team of six rescuers consisting of two primary entrants, two standby entrants and two attendants. Includes 100' of cable for each entrant (expandable to 1500 ft.). System can be configured for up to fourteen people using available modules and accessories.

304015P Rescue Kit 5, Power Talk



### Victim Locator Kit Confined Space Rescue Probe

For structural collapse - includes the unique CON-SPACE Rescue Probe designed to detect and communicate with victims trapped in collapsed structures. Intrinsically Safe Approved.

30310031 Victim Locator Kit



### USAR Task Force Communication Kit

A multi-use Urban Search and Rescue Task force Kit designed to meet the needs of Confined Space, High Angle, Structural Collapse, Victim Location, Shoring, Tunneling and Trench Rescue. The USAR Kit can be configured according to the type of rescue involved, so whether it's a two-in-two-out or a five person Search and Rescue team this kit has you covered. Intrinsically Safe.

3034055 USAR Task Force Comm Kit





### Bomb Disposal Kit

Private communications for team of 3 Bomb Specialists wearing Face Shields and Full Body Armor. System is NON-RF emitting - conforms to MIL-STD 461. Intrinsically Safe Approved.

30310030 Bomb Disposal Kit



### Cable and Accessories

30204050	50' w/ Connector
30204100	100' w/ Connector
30311050	50' w/ Strain Relief Hook
30311100	100' w/ Strain Relief Hook



### Hose/Cable Umbilical Zippered in Multiple Colors

New style zippered hose / cable protections. Four colors to allow accurate selection of hose/cable/lifeline combinations.

#### 50 Foot

303010501	Black
303010500	Orange
303010502	Yellow
303010506	Blue
303010504	Red

#### 100 Foot

303011001	Black
303011000	Orange
303011002	Yellow
303011006	Blue
303011004	Red

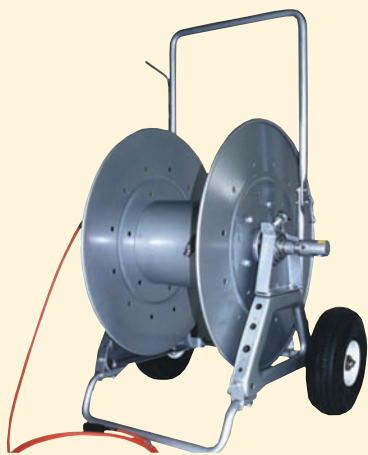

### Cable / Air Hose Reel

Communicate while reeling in or out. Cable is fully protected, easily handled, and safely stored. Cable & Hose not included.

30120520	200 ft. Reel with Wheels
30120530	300 ft. Reel with Wheels
30120225	250 ft. Reel
30120250	500 ft. Reel

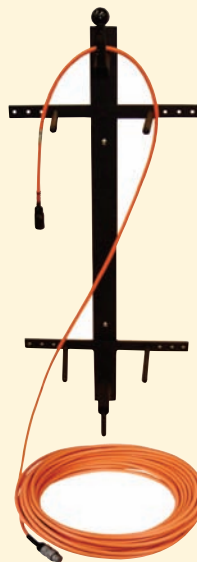

### Con-Space Cable Coiler

Coils your CON-SPACE Hardline Communication Cable through a unique figure 8 looping system that allows for simple, untangled deployment in the field. Cable not included. Dimensions: 32" x 14". Creates coils that are 29" x 7"

30301040 Con-Space Cable Coiler



### Con-Space Cable Bag

Stores and allows for easy transport of your Hardline Cable. Holds 100 ft. - 300 ft. of Con-Space Cable. Cable not included. Dimensions: 32"l x 11"w x 6"h.

30303007 Con-Space Cable Bag

**WARNING**

Technical rescue and safety is potentially hazardous. Any person using equipment sold by RESCUE TECHNOLOGY in any manner is personally responsible for learning the proper techniques involved, and assumes all risks and accepts full and complete responsibility for any and all damages or injury of any kind, including death, which may result from the use of any RESCUE TECHNOLOGY equipment.





## RAMFAN UB20 Blower System

Provides the industry's highest certified CFM for either exhausting or discharging air with 8" duct. Easily attached 15 - 25 ft. duct canister works at either end or both ends. The UB-20 has RAMFAN's uniquely designed turbo blade which creates a straight, non-spiraling airflow. Motor: 1/3 hp, 60 Hz, 115 - 230 VAC, 2 amps. Optional DC motor. Manufactured of Double Wall lightweight, rugged polyethylene.



Blower Dimensions: 13"h x 12"w x 13"d.  
Blower Weight: 16 lbs.

Airflow:

Freeflow	1-90°	2-90°
980 cfm	789 cfm	666 cfm

- 3270015 Blower w/ 15 ft duct AC
- 3270025 Blower w/ 25 ft duct AC
- 329015 Blower w/ 15 ft duct DC
- 329025 Blower w/ 25 ft duct DC
- 325508 Blower ONLY, 115 v AC
- 329002 Blower ONLY, 12 v DC
- 3203605 Battery Connector, 5 ft.
- 32034214 UB20 Battery Pack Charger

Performance measured by CEESI.



## Saddle Vent Blower System

Complete Confined Space System

Ready-built system for your confined space team. Available with Standard UB20 Blower or UB20XX Extreme hazard Blower and 5 ft. and 15 ft. duct.

- 327025S 20' System
- 327025XS 20' Hazard System



## RAMFAN UB20XX Extreme Hazard Blower

Same high quality blower mechanism as the standard UB20 with a conductive housing and duct. When properly grounded, the system virtually eliminates static discharges. Manufactured with Anti-Static housing. Totally enclosed hazardous location motor rated UL Class I, Group C,D; UL Class II, Group E,F, G. 30 ft. Cord w/ power switch. Plug not included. Blower Dimensions: 13"h x 12"w x 13"d. Blower Weight: 21 lbs.

- 3270115 UB-20XX w/ 15 ft duct AC
- 3270125 UB-20XX w/ 25 ft duct AC
- 3270102 UB-20XX Blower ONLY

Performance measured by CEESI.



## UB20 Heater System

A complete system to warm your atmosphere. Produces 55,000 BTU's to easily heat confined spaces, tents, shelters, Decon Areas. System Includes: UB20 Blower, Heater Unit, 25 ft. of 8" duct, and LP regulator w/ 12 ft. LP Hose.

- 32037125 UB20 Heater System



## RAMFAN EFI75 12" High Output Blower

RAMFAN combines aerospace fan design with high-strength polymers to produce a rugged high output portable blower for confined space and hazardous ventilation. Glass-reinforced Double Wall ABS housing handles the bumps and falls of the job site. UL listed motors. Advanced blade design increases head pressure and provides the power you need to meet difficult to ventilate conditions. Extreme Hazard Models constructed of carbon-reinforced ABS rated UL94HB. Resistivity: 100k ohm or less. Rated Class I, Group D, Class II, Group E, F, G. Supplied with junction box (no cord/no plug). Dimensions: 16" x 15" x 15". Weight: 38 lbs.

Airflow (cfm):

Freeflow	Straight	1-90°	2-90°
2500	1743	1664	1529

- 327512 12" Blower
- 327512X 12" Extreme Hazard
- 3210112 12" to 8" Duct Adapter

Performance measured by CEESI.

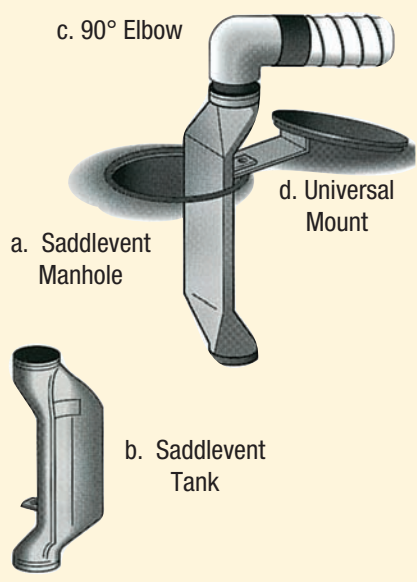

## Saddle Vent For Use With 8" Duct

- a. 3220189 Manhole, Std
- b. 3220189T Tank
- c. 3220190 90° Elbow
- 3221190X 90° Elbow, Conductive
- 3220190T 90° Elbow, Tank Style
- d. 322098 Universal Mount
- 3221189X Manhole, Conductive

## Technical Rescue Air Cart

### Simultaneous Respirator and Air Tool Operation

Separate high (275 psi) and low (125 psi) pressure regulated air systems. Additional high pressure inlet port allows connection to outside air source for extended use applications. High pressure isolation valve and toggle switch allows user to switch between common or isolated air sources. Operable via cylinder air or mobile air truck. The system includes two connecting hose whips with bleed valves and inline check valves, adjustable heavy duty high flow pressure regulator with relief valve, dual pressure gauges for cylinder and outlet pressure readings, low cylinder pressure alarm, breathing air manifold with quick-disconnect Hansen couplings. 275 psi or 125 psi pressure relief valve. 3 way selector valve allows operation with left cylinder, right cylinder, or High Pressure Inlet. Dimensions: 35"H x 20.5" W x 15" D. Weight: 54.5 lbs (without cylinders). Respirator Regulator: 0 - 5500 psi inlet; 0 - 125 psi outlet. Tool Regulator, High Pressure: 0 - 6000 psi inlet; 0 - 275 psi outlet. Tool Regulator, Low Pressure: 0 - 300 psi inlet; 0 - 125 psi outlet. Flow Rate: 80 cfm @ 120 psi. Outlet Fittings: four (4) 1/4" Quick-Disconnect Fittings. Accepts cylinders up to 4500 psi pressure rating.

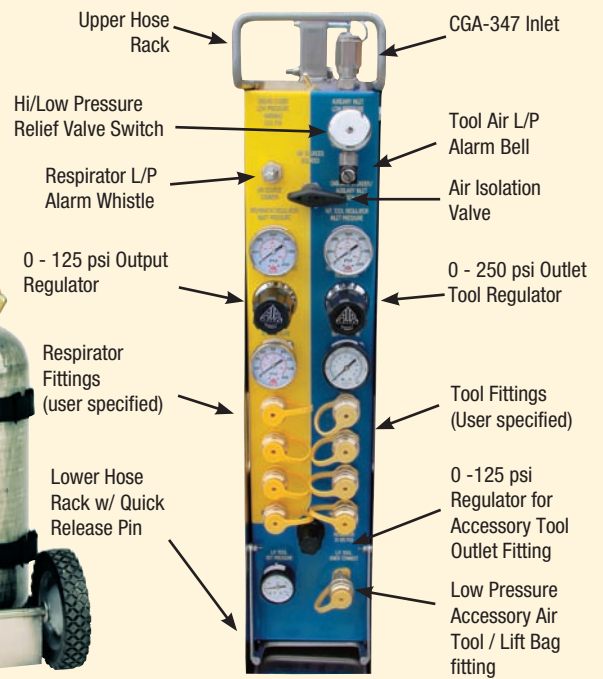
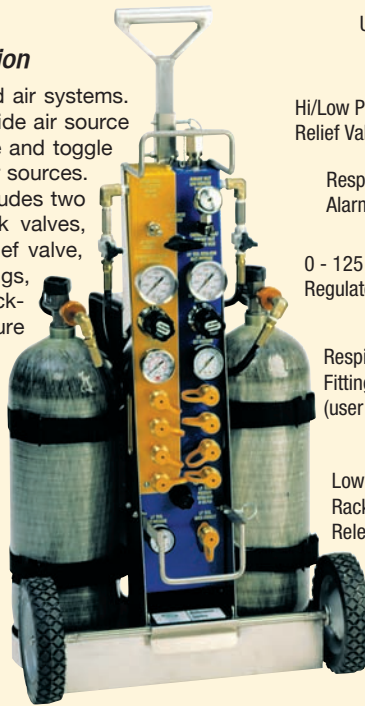

2009114H	Technical Rescue Cart, 1/4" Hansen Fittings
2009225	25 ft. High Pressure Connect Whip (for Cascade)
2009119	Cart Cover

Exceeds NIOSH guidelines for point of attachment.

## Air Supply Hose

High quality air supply hose with Hansen fittings to fit the Technical Rescue Air Cart.

20095457H	50 ft.
20095458H	100 ft.



## RAMFAN Accessories

### 8" Duct

320815	Standard Duct, 15 ft.
320825	Standard Duct, 25 ft.
320815C	Conductive Duct, 15 ft.
320825C	Conductive Duct, 25 ft.
3210108C	Duct Coupler, 8"

### 12" Duct

3211215	Standard Duct, 15 ft.
3211225	Standard Duct, 25 ft.
3212215	Conductive Duct, 15 ft.
3212225	Conductive Duct, 25 ft.
3210112C	Duct Coupler, 12"

321014	Storage Bag, 8" x 15'
321015	Storage Bag, 8" x 25'

321012	Storage Bag, Medium Fits: 12" x 15'/25'/15' Cond.
--------	--

321013	Storage Bag, Large Fits: 12" x 25' Conductive
--------	--



## Spectrum Pressure Demand Airline Respirator

### With Escape cylinder

Complete low profile airline respirator to meet NIOSH requirements. Excellent visibility. Respirator includes: Full Facepiece, First and Second Stage Regulator Assembly, Harness Assembly with a 10 minute ESCBA cylinder. Add air supply hose and system constitutes a NIOSH Approved respirator. Excellent for work in confined space and IDLH environments.

20092110H	Respirator, Hansen
-----------	--------------------



Power Articulating Camera Head



## Vision Stick™ Rescue Video System For USAR, Haz-mat and Fire Rescue

- \* Forward Viewing
- \* Power Articulation
- \* Focus optimized for 3-4 feet
- \* Fits easily into small diameter holes

### Specifications

Camera	Color, 1/4" Sony Super HyperCAD™ Sensor
Head Diameter	1.5"
Sensitivity	0.5 LUX 380 TV Lines resolution
Illumination	High output white LEDs
Image Orientation	Variable, easily changed so image is always up right
Articulation	+/-90° Remote Power Articulation, controlled from ring on proximal end of probe. Direction indicator lamp indicates when unit head is in line with probe. Sealed Liquid tight for gasoline and aqueous liquids
Pole Lengths	5 ft. to 12 ft. (standard) 7.5 ft. to 20 ft. (special order)
Pole Construction	Fiber Glass with Quick Lock Cuffs.
Cabling	Internally wired probe. Short External coiled cable to Display / Power module avoids tangling. 5 ft. extension supplied.
Sound	Microphone located in LED Array. Earphones connected to display power module. (Included on "Sound" models only)
Display	3.5 LCD High Bright Monitor
Battery Life	2 Hours Continuous Use



Electronic Power Articulation Controls



<b>2375111</b>	Vision Stick "V" Series, Color w/ Sound
<b>2375113</b>	Vision Stick "V" Series, Black/White Infrared w/ Sound
<b>23752115</b>	Vision Stick Dual, Color/Infrared
<b>23752116</b>	Vision Stick Dual, Color/Infrared w/ Sound
<b>2375183</b>	Replacement Battery

Microphone

Thermal Imaging Camera



Color Camera

Vision Stick Color / Thermal Imaging Camera Head

## Vision Stick™ Rescue Video Color / Thermal Imaging Color and Thermal Imaging Cameras on One Unit



One forward-viewing thermal imaging camera and one forward viewing color camera with white light illumination, integrated into a single camera head. The Vision Stick comes complete with an easy access control pad for viewing and control options. Electronic controls provide ability to control the power articulation of the camera head form the base of the pole. Built-in omni-directional microphone. Length: Adjustable from 57" - 10'6".

Weight: ~4.3 lbs..  
Head diameter: 2". head Length: 6.5".  
Camera Articulation: 180° total (90° from center).

**2375120** Vision Stick, Thermal/Color



Headset  
(Included w/ Sound Systems)



## SEARCHCAM 2000®

The entire system consists of: the probe, video monitor, headphones with boom microphone, sun shield, lanyard, two batteries, battery charger, field maintenance kit, operations and maintenance manual, and carry/storage case. The components are stored in one Pelican®, foam lined, high impact plastic, water and dust tight, carrying case with wheels. The packed unit weighs 59 pounds (26.8kg).

- High Resolution Color Camera
- Acoustical Search Microphone
- Speaker
- Variable Intensity Illumination
- Articulated Head
- Remote Control

21709920002	Probe w/ Audio
21709920001	Probe
21709920101	Victim Simulator



## SearchCam SearchTIC® Thermal Imaging Camera

Full 5" display for large detail filled images. BlueLife™ image colorization displays skin temperatures in brilliant Blue to aide in rapid detection of victims. Integrated digital compass, displays viewing direction on-screen to assist in pinpointing a victim's location for rapid rescue. Digital zoom (2x) allows for detailed area search from a safe distance. Uses the new Lithium Ion rechargeable battery tube pack as well as disposable cells and the Searchcam belt pack battery system making the SearchTIC power compatible with hundreds of rescue teams around the world.

21709920201	SearchTIC
-------------	-----------



Shown with sunshield\*

## SearchCam Recon II®

The Recon II provides rescue squads with a general purpose camera system that is tailored to the task typically assigned to the rescue squad. The Recon II enables rescue squads to perform limited visual search through multiple debris layers, as well as victim observation after the Search Team has moved on to other locations. The Recon II is small enough to be easily maneuverable in the rubble, yet will extend long enough to be effective for multi-floor search operations. Effective viewing distance is as close as a few inches to over 10 feet (3 m) in total darkness. Compatible with all Searchcam 2000 accessories and batteries.

- Color Camera with DSP Color Control
- 5" LCD Detachable Display
- Integrated White LED Illumination
- 180 degree Manual Articulating Head
- Telescoping Probe ( 31" to 45")
- Lightweight: 4.5 lbs with Display
- Rechargeable Batteries with Minimum
- Run Time: Two Hours at Full Load
- Works with Searchcam 2000 Accessories

21709920101	
-------------	--



## Delsar Life Detector LD3

Rescue teams around the world have relied upon the LifeDetector for over 15 years to rapidly detect and locate victims of collapsed buildings. The LifeDetector essentially converts the entire collapsed structure into a large sensitive microphone to pinpoint signals from the entombed victims. The seismic and acoustic sensors of the system convert vibrations created by the live victim into audible and visual signals.

- Improved color-coded cable connectors
- Allows two acoustic search probes to be used simultaneously for stereo comparison.
- Audio loop record function records last five minutes of audio for playback and comparison.
- Display panel shows relative signal strength of all six sensors simultaneously. Peak meters indicates highest amplitude reached by each sensor.

21709920306	6 Sensor
21709920304	4 Sensor
21709920302	2 Sensor

21709920311	Delsar Victim Simulator
-------------	-------------------------





UTD Quick Deploy System



UTD Camera w/ Handle

## Vision Stick Under the Door (UTD)

The Vision Stick UTD system module is flat paddle camera, which will slide under a door to view what is on the other side. The system plugs into the Vision Stick monitor power supply. A handle is supplied with the system, which allows controlling the system while standing.

The Vision Stick UTD system has a 95° field of view which is off set 30° from the floor which allows viewing the whole room, including beside the door because of its long paddle. The paddle has been left a matte silver cover, since it is less obvious than black against most surfaces and tends to pick up the color of surrounding areas helping it avoid detection of use.

- The UTD Camera with handle is designed to be used as an accessory to the Vision Stick System - Monitor not included.
- The UTD Camera System includes camera, monitor, headphones and Handle.
- The UTD Quick Deploy system is a self-contained video and sound monitoring system. The System includes the UTD Camera, Handle, Headphones, Monitor, and Auxiliary Hole Camera.

2375201	Camera w/ Handle
2375205	Camera System
2375206	Quick Deploy - IR
2375207	Quick Deploy - Color
2375208	Quick Deploy - IR / Color



## Triage Belt

A unique belt designed for use within the start triage system. It utilizes four colors of survey tape to categorize patients. The triage officer simply tears off a piece of colored tape and ties it around the patient's arm, which can be seen and understood from many yards away, unlike standard tags. The officer then tears a small piece of tape of the same color and placed in the side pouch of the belt. When done with the primary triage, the officer can check the contents of the pouch for an instant count of patients and their severity. Tape not included.



Tape not included

833100	Triage Belt
833115	Triage Tape (Green)
833112	Triage Tape (Yellow)
833114	Triage Tape (Red)
833111	Triage Tape (Black/White)



Equipment not included.

## Command Board

The Accountability / Command board helps keep track of rescuers and organizes your incident command structure. It features an 18" x 24" dry erase board with the ICS structure screened on it. Includes velcro strip for name tags and twin flashlight harnesses to light the board. Manufactured from padded Ballistic nylon, pockets accommodate two radios or cell telephones and zippered pockets for clipboards, command vests, and writing utensils. The case will stand by itself or hang from a vehicle window or roof gutters to make a handy command station/table.

809801 Command Board

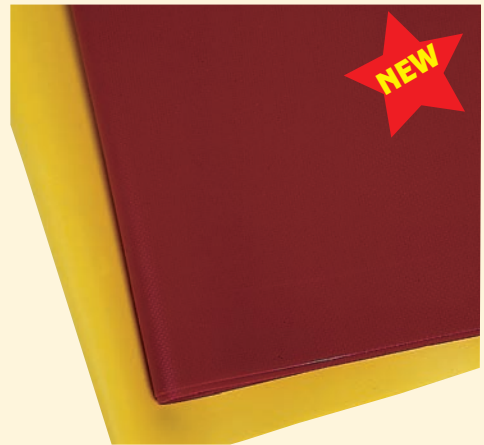

## Triage / RIT Tarp

Constructed from heavy duty PVC Coated 14 oz. fabric. Can be easily washed down. Brass grommets in corners. Dimensions: 10' x 12'. Available in Green, Red or Yellow

8330105	Green
8330104	Red
8330102	Yellow





### GX2003 4 Gas Monitor 3 Operating Modes

Built around high-quality micro-sensor personal 4-in-1 gas monitor with a built in sample pump.  
Weight: 11 ounces

- 3 modes: Normal, Bar Hole, and Leak Check
- Monitors LEL, %volume methane, O2, H2S, CO
- Leak detect mode offers high sensitivity tests for ppm level natural gas leaks
- 0 to 100% volume Methane
- Auto-ranging display of %volume and %LEL
- Internal sample pump - 40' range
- Vibration, visual, and audible alarms
- Automatic backlight during alarms
- Quick charge Ni-MH Battery (charge in 90 min.)
- High impact protective rubber boot
- Up to 600 hours of datalogging
- Autocalibration or single calibration
- TWA and STEL with lunch-break mode
- Intrinsically safe, CSA, C/US classified
- 2 year warranty

243227103	GX-2003, 115 VAC Charger
243227101	GX-2003, 12 VDC Charger
243720270	GX-2003, Alkaline Battery



### GX2001 4 Gas Personal Monitor

The smallest and most affordable 4-gas monitor in the world. Designed to give entrants immediate information on the confined space.

- Simultaneous detection of LEL/O2/H2S/CO
- Dimensions: 2.8" x 2.2" x 1.1"
- Weight: 6 oz
- Vibration alarm
- Alarm trend data
- Datalogging standard
- Autocalibration
- Ni-MH batteries recharge in 90 minutes
- Operates for up to 18 hours
- Large LCD display screen
- Automatic backlighting at alarm
- High impact, RFI shielded body
- STEL and TWA readouts
- Peak hold readouts
- Continuously displays current time
- Intrinsically safe, CSA, C / US approved
- 2 year warranty
- Includes Charger

2432233031	115vAC -Alligator Clip,
2432233011	12vDC - Alligator Clip



4" Nipple Model with GX2001  
(Not Included)

### RP-6 Pump For GX2001 Four Gas Monitor

The RP-6 pump is housed in a rugged plastic case with quick connect fittings located on both ends of the unit. It is sold with either a 4" rubber nipple or with a 10' hose and probe. When buying the RP-6 with the 10' hose and probe, the probe is equipped with a dust filter and the 10' hose connects at the RP-6's quick connect inlet fitting. The inlet fitting of the RP-6 then connects to a removable clear plastic cup, which is a filter holder. This filter holder contains a dust and hydrophobic filter inside. The exhaust fitting of the RP-6, which is also a quick connect, connects to a coiled hose, which brings the sample to the GX-2001. The RP-6 will run for 5 hours from just 1 AA alkaline battery.

243281166 10' Hose and Probe



GX2003 Kit

### Calibration Kit

Complete calibration kits for our 4 gas instruments. Each kit contains 34 liter aluminum cylinder with H2S (25ppm) / CO / CH4 / O2, Regulator, Case, and appropriate interface device for the instrument.



Kit shown with  
GX2001 (not included)

2432810301	GX2003
2432810101	GX2001



## ▲ WARNING

Technical rescue and safety is potentially hazardous. Any person using equipment sold by RESCUE TECHNOLOGY in any manner is personally responsible for learning the proper techniques involved, and assumes all risks and accepts full and complete responsibility for any and all damages or injury of any kind, including death, which may result from the use of any RESCUE TECHNOLOGY equipment.



Shown with HT-1250 Radio. Not included



## Deluxe Radio Chest Harness

One-Size-Fits-All radio harness will adjust to hold any radio snugly to your chest. The vertical orientation of the radio improves reception, extends antenna life, and reduces the chance of chest injury during a fall. The unique suspension system of 1.5" webbing shoulder straps and elastic chest strap, virtually guarantees that the harness will not bounce or swing, even while crawling through confined spaces. Twin buckles ease the donning of the elastic chest strap. The harness features a large bellows cargo pocket, pen pouch, and twin elastic antenna keepers. ID Version includes a removable ID pocket with ID window. Weight: 9.1 oz. Color: Black.

- 820301 Deluxe
- 820302 Deluxe w/ ID Pouch **NEW!**



ID Version



Shown with HT-1250 Radio. Not included



## Mesh Radio Chest Harness *Lightweight, Breathable*

A lightweight version of our Deluxe Radio Chest Harness. Adjustable webbing shoulder straps with quick-adjust elastic chest strap. Mesh provides excellent ventilation for hot climates. Elastic loops hold pens, flashlights, etc. Color: Black.

- 820305 Radio Chest Harness



Shown with HT-1250 Radio and Garmin V GPS. Not included



## Rescuetech USA Radio Chest Harness *With Integral GPS Holder*

The use of Radios and GPS units during natural disasters is a given. We found during the rescue operations following Hurricane Katrina, that existing radio chest harnesses did not meet the needs of rescue teams. We have updated our popular Deluxe Radio Chest Harness to include a see-through compartment for a Garmin V™ GPS, additional storage space, redesigned straps system, and many other features.

- 820325 USA Radio Chest Harness



Shown with HT-1250 Radio. Not included

## Double Radio Chest Harness

Same suspension and adjustment as the Deluxe Radio Chest Harness. Carries two radios, one on each side of platform with a center pocket for extra batteries, etc. Second radio pocket can also carry GPS unit or cell phone. Weight: 9.6 oz. Color: Black.

- 820321 Double Radio Harness



## Incident Command I.D. Badge Holder

Designed to hold I.D. Badges during Disaster Response. Safely stores permanent and temporary identification cards. Security pouches holds extra paperwork, currency, etc. Adjustable webbing neck strap. Water-resistant magna tuf fabric. Heavy duty polished clear vinyl allows I.D. Tags to be easily read by scene safety and security personnel. Pen / Penlight holder keeps items ready for instant access.

- 820201 ICS Badge Holder

## I.D. Badge Attachment *For Deluxe Radio Chest Harness.*

Compact I.D. Attachment for the Rescue Tech Deluxe Radio Chest Harness or Double Radio Chest Harness. Made from the same high quality materials as our ICS Badge Holder. Pouch easily attaches to pouch closure system.



- 820205 ID Badge Attachment

**⚠ WARNING**

Technical rescue and safety is potentially hazardous. Any person using equipment sold by RESCUE TECHNOLOGY in any manner is personally responsible for learning the proper techniques involved, and assumes all risks and accepts full and complete responsibility for any and all damages or injury of any kind, including death, which may result from the use of any RESCUE TECHNOLOGY equipment.





**NEW**

**Kershaw Blur Serrated**

The Blur's handle is built from anodized 6061-T6 aluminum with "Trac-Tec" inserts for an extremely secure grip even in the most damp or slippery conditions. The blade is made out of 440A stainless steel and measures 3.5". Easy opening with Speed Safe technology. Folded, the Blur measures 4.5" and weighs in at a comfortable 4.2 oz.

2282376794	Rescue Tip Serrated
2282376796	Serrated (Black)
2282376797	Serrated (Red)



**NEW**

**E-Z OUT RESCUE**

The E-Z Out Rescue features a blunt tip design on the fully serrated sheep foot stainless blade that makes this knife safer to use in situations where you don't want to risk puncture. Features a yellow handle with black Kraton® non-slip rubber inserts, removable pocket clip and lock back. Closed: 4.62". Blade: 3.5". Weight: 2.6

2282376647



**NEW**

**Rescue Hook**

Form and function same time and effort for the rescuer. Manufactured of 440C stainless steel with a molded Kytex sheath. The Rescue Hook's blade has a length of 0.85" and a thickness of 0.115". Overall Length: 2.90".

2282327040



**NEW**

**LEEK PARTIALLY SERRATED**

The Leek has a bead-blasted 410 stainless-steel handle, with a 440A stainless-steel blade. Opens with Speed Safe technology. Blade: 3", closed: 4". Weight: 3.1 oz.

2282376802



**NEW**

**Kershaw Scallion  
Aluminum and Polyamide Handle**

Scallions are designed with Speed-Safe technology, which allows you to open the knife safely and quickly with one finger. A locking liner secures the blade in position once it is deployed. Thumb lock keeps knife securely closed. Scallions are made with durable anodized aluminum handles and stainless-steel blades. Heavy-duty, removable carrying clip. The Black Scallion is made with durable injection molded Polyamide handles and stainless-steel blades. Heavy-duty, removable carrying clip. Blade Length: 2.4" Handle: 3.5" Weight: 2.3 oz.

20842766	Aluminum Handle (Blue)
20842767	Polyamide Handle (Black)



**NEW**

**Wingman**

The Wingman Knife's flip-out blade fulfills your need for speed. Its safety features help you break out of the danger zone. Easily deployable one hand flip-open blade for when you feel the need for speed. Knife has a blunt tip and both smooth and serrated blade sections. The blade locks open for safety and the handle has a blunt glass-breaking tip. Removable spring steel clip is always ready for action when secured to a belt or lash tab.

20842771

**⚠ WARNING**

Technical rescue and safety is potentially hazardous. Any person using equipment sold by RESCUE TECHNOLOGY in any manner is personally responsible for learning the proper techniques involved, and assumes all risks and accepts full and complete responsibility for any and all damages or injury of any kind, including death, which may result from the use of any RESCUE TECHNOLOGY equipment.



**NEW**

**Spyderco Assist  
Rescue Knife  
With Glass Breaker**

Made for the fire/rescue professionals, the Assist features a carbide glass breaker, sure grip FRN handle, 80% serrated blade, VG-10 high-carbon blade steel, survival whistle built into the handle and wire clip. Blade and handle shape are designed to allow controlled rope cutting without an exposed cutting edge. Place the rope between the partially closed blade and the handle then squeeze the blade shut. Length: blade 3.69", closed 4.875". Wt: 4 oz.

2282376549



**Spyderco Rescue Knife**

VG-10 blade steel and fully serrated with a sheepfoot tip. Large thumb hole with texturing behind it and the FRN volcano grip textured handle. Blade thickness: 1/8"

		Open	Color
2282376553	79mm	7 1/8"	Orange
2282376530	93mm	8 1/8"	Black



**Spyderco Ladybug**

The smallest knife with full Spyderco power for your pocket (without clip). High-carbon stainless blade. Zytel handle. Open length: 4.4". Closed length: 2.5". Weight: 0.6 oz

2282376522 Ladybug, Black





**RescueTECH  
Technician's Gloves**  
*Mesh Back / Goatskin Palm*

With comfort and utility in mind, we designed these rescue gloves especially for the rope rescue technician. By using a combination of goatskin, mesh fabric, and amara leather, we offer the optimum combination of materials that make your job safer and easier. Fingertips designed for handling locking gates on carabiners and tying knots.

491329	Small
491339	Medium
491349	Large
491359	XLarge



**Heavy Rescue**  
*Cowhide shell/Cowhide Wear Pad*

Glove design incorporates double palm with wear pad extending up the individual fingers and thumb and around to the back of the hand, leaving a single layer at the finger tips for superior tactile capabilities. This protective design utilizes no loose flaps or webs between the fingers that can trap dirt or roll up during use. Flexible design permits ease in rope handling. Leather loop allows for attachment to carabiners. Color: Black. Weight: 6.1 oz.

490521	Small
490531	Medium
490541	Large
490551	XLarge
490561	XXLarge



**Pro Rescue Glove**  
*Mesh Back / Leather Palm*

The Pro leather gloves are perfect for those jobs that are especially hard on the hands. When anything less than a leather glove won't do. Top quality leather construction throughout. Leather knuckle panel provides increased protection. Easy entry, wide opening elastic cuff (Easy-Fit design). Anatomically-cut, leather palm and heel reinforced panels for extended durability. Smooth surface thumb improves handling of objects. Reinforced thumb and fingertips increase protection and reduce wear.

491221	Small
491231	Medium
491241	Large
491251	XLarge
491261	XXLarge



**Ringers Rope  
Rescue Gloves**

Omni-directional stretch fabric offers flexibility and excellent airflow. Palm manufactured of Armortan® leather that can be machine washed to remove contaminant. Double thickness in palm with DuPont Kevlar® thread for long wear. Reinforced finger tip and thumb extends glove life. Precurved ergonomic shape and anti vibration gel padding for extra comfort. Specify Size.

4907X4	Red (SM - XXL)
4907X1	Black (SM - XXL)



**Rigging Glove**  
*Mesh Shell / Amara™ Palm*

Breathable Mesh for Increased ventilation. Smooth surface thumb and index finger improve handling of objects. Reinforced thumb and fingertips increase protection and reduce wear. Neoprene knuckle panel provides increased flexibility and protection. Anatomically cut, foam-padded palm lessens impacts and reduces vibration. Soft, flexible, durable and breathable synthetic leather palm. Easy entry, wide opening elastic cuff. Pull cord on wrist for easy entry and for hanging gloves after use.

490221	Small
490231	Medium
490241	Large
490251	XLarge
490261	XXLarge



**Leather 3/4 Finger Glove**

Genuine leather, extra gel-foam padding in palm. Great for rigging and stagehands. 2-way stretch spandex top. Flexible, soft, durable and breathable leather palm.

4906121	Small
4906131	Medium
4906141	Large
4906151	XLarge
4906161	XXLarge

**RescueTECH Glove Sizing**

Measure around widest portion of hand

XSmall	5 - 7"	Large	9 - 10"
Small	7 - 8"	XLarge	10 - 11"
Medium	8 - 9"	XXLarge	11 - 13"





### USAR Knee and Elbow Pads

Great for use in building collapse searches. Velcro closure and tough cap. Provides heavy duty protection for the toughest jobs.

		Weight
481611	Knee Pad, pair	13.7 oz.
481621	Elbow Pad, pair	5.60 oz.



### Glove Strap

Manufactured from durable nylon webbing with plated steel trigger snap. Closes around glove with quality hook and loop fastener.

491901 Glove Strap

### Seat Belt Cutter

A lightweight seat belt cutter. Will easily cut through webbing and cords with ease. Manufactured from high impact plastic with hardened stainless steel blade. Dimension: 4.75" x 1.75". Weight: 1 oz.



630101 Seat Belt Cutter

### EMT Shears

Safer than a knife when used around ropes. Safety bandage tip. Stainless Steel Blades. May be placed in Autoclave. Cuts clothing, ropes, or harnesses. Stainless Steel blades with polypropylene handles. Length: 7". Weight: 2 oz.



630105 EMT Shears



### Elastic Glove Cinch

Manufactured from durable stretch cord and high quality cordlock. Elastic holds gloves in place. Girth-hitch this Cinch around gear loops, waist belts, and D-rings to keep gloves ready to use.

491902 Elastic Glove Cinch



### EMT Shears Pouch

A new design from Rescue Technology. Made from Durable Magnatuf coated nylon fabric. Features glove pouch, shears pouch with hook and loop keeper and a pouch for penlights, pens, etc. Fits onto belts with a quick removable snap system. A plus for safety. Shears not included.

833010 EMT Shears Pouch



### Latex Glove Pouch

Made from our high quality nylon fabric and top grade hook and loop fastener. Holds multiple pairs of gloves.

833001

## ▲ WARNING

Technical rescue and safety is potentially hazardous. Any person using equipment sold by RESCUE TECHNOLOGY in any manner is personally responsible for learning the proper techniques involved, and assumes all risks and accepts full and complete responsibility for any and all damages or injury of any kind, including death, which may result from the use of any RESCUE TECHNOLOGY equipment.





### R3-Kiwi™ USAR Helmet Certified NFPA 1951

Lightweight Kevlar brand fiber / composite shell. Temperature resistance up to 600° F without distorting or melting. Polyurethane impact liner with leather sweatband provides impact and thermal protection. Reflective Trim. High-gloss paint finish. Ratchet headband with easy-to-dial adjuster. 3 point nomex chin strap. Certified NFPA 1951, EN443. ANSI X89.1 Type 2 compliant. Custom lettering with clear coat finish available.

481434	Red
481436	Blue
481432	Yellow
481439	White



### USRX™ Urban Search and Rescue Helmet

Innovation, quality, and service in an all new lightweight, compact design. USRX rescue helmets are engineered Bullard Tough™ for extreme search and rescue conditions. Featuring a streamlined design, USRX rescue helmets incorporate recommendations from USAR teams and other rescue professionals. Features and Benefits Compliance • NFPA 1951-2001 • NFPA 1971-2000 Tough and Durable Protection. Bullard Tough. Quick, Easy ratchet headband offers both a quick-turn of the knob and a new, unique 3-position height adjuster for balance and comfort. The USRX is standard equipped with leather covered ratchet and a 3 point chin strap. The USRX comes standard with ESS goggles. Cost-Effective Maintenance USRX helmets are designed from the start to make maintenance simple and cost effective. Fewer components, and the greatest cost effectiveness in the industry, enhance your long-term investment.

480522	Yellow
480524	Red
480526	Blue
480529	White



### Reflective Helmet Labels

Reflective Labels that are a great addition to helmets. Reflectivity adds to safety and identification.

482101	"Rescue" Crescent
482104	"Fire Rescue" Crescent
482103	"Instructor" Crescent
482106	"Rescue Chief" Crescent
482107	"Rescue Squad" Crescent
482108	"Haz-Mat" Crescent
482109	"Chief" Crescent
482212	Stripe, 1" x 4", pair (YE)
482222	Trapezoid, Set of 5 (YE)
482111	Star of Life Decal



### Advent A-2 Helmet

Conventional styling. Offers top, front, side and rear protection similar to a standard firefighter's helmet. The A-2 offers a permanently attached multi-point chin strap designed especially for search and rescue operations. Eight point suspension for increased comfort and safety. The ratchet suspension quickly adjusts to size. Available Adhesive clips make attachment of almost any lamp with a head band a breeze.

480530	Orange	480565	Repl. Suspension
480534	Red	480555	Adhesive Clips, Set of 3
480539	White		
480532	Yellow		
480536	Blue		

Meets ANSI 289.1 and OSHA 1910 requirements

### ▲ WARNING

Technical rescue and safety is potentially hazardous. Any person using equipment sold by RESCUE TECHNOLOGY in any manner is personally responsible for learning the proper techniques involved, and assumes all risks and accepts full and complete responsibility for any and all damages or injury of any kind, including death, which may result from the use of any RESCUE TECHNOLOGY equipment.





### R3-Kiwi Rescue Helmet

The ultimate in comfort and protection. DuPont Kevlar® shell and full polyurethane impact headliner. Proven in the field by USAR/FEMA and Task Force One personnel. Adjustable Ratchet Headband with multi-point chin strap. Light pod version works best with UK4AA . ANSI Z89.1 Type 2 compliant.

4815314	R3 Kiwi (Red)	4815324	R3 Kiwi, Light Pod (Red)
4815316	R3 Kiwi (Blue)	4815326	R3 Kiwi, Light Pod (Blue)
4815312	R3 Kiwi (Yellow)	4815322	R3 Kiwi, Light Pod (Yellow)
4815319	R3 Kiwi (White)	4815329	R3 Kiwi, Light Pod (White)

### WR2000 Multi-Use

*For High Angle and Water Rescue*

Shell made with Dupont Kevlar® with 9 ventilation holes. 6 point suspensions with dial ratchet. 3 Point nylon chin strap with quick-release buckle. Ratchet adjustment expands to 25". ANSI Z89.1 compliant.

481544	WR2000 Helmet, Red
481546	WR2000 Helmet, Blue
481549	WR2000 Helmet, White



### R5 Kiwi Rescue Helmet

Manufactured of DuPont Kevlar® shell. Very Lightweight with a small profile for work in confined spaces. Multi-Point chin strap. Adjustable ratchet headband. One Size Fits All. Light Pod version works best with UK4AA. Complies to AS 1801 and ANSI Z89.1 Type 1.

4815524	R5 Helmet, Light Pod (Red)	4815514	R5 Rescue Helmet (Red)
4815526	R5 Helmet, Light Pod (Blue)	4815516	R5 Rescue Helmet (Blue)
4815529	R5 Helmet, Light Pod (White)	4815519	R5 Rescue Helmet (White)

### R4 Helmet

Similar in construction to the R3, the R4 has a high gloss woven all-Kevlar® RTM shell. Polyurethane full head impact liner. Front Leather headband with a dial ratchet adjustment system. ESS Goggle Mounts. 3 point chin strap. Compliant to ANSI Z89.1, Type I, Class G. Weight: 1.7 lbs.

481564	R4 Helmet (Red)
481566	R4 Helmet (Blue)
481569	R4 Helmet (White)
481562	R4 Helmet (Yellow)

## ▲ WARNING

Technical rescue and safety is potentially hazardous. Any person using equipment sold by RESCUE TECHNOLOGY in any manner is personally responsible for learning the proper techniques involved, and assumes all risks and accepts full and complete responsibility for any and all damages or injury of any kind, including death, which may result from the use of any RESCUE TECHNOLOGY equipment.



Shown on R3 Helmet with Light Pod (not included)

### Xtricator™ Goggles For R3, R4, and R5 Rescue Helmets

The ideal solution for primary eye protection for extrication and forcible entry work. Snaps onto the goggle attachment points of the R3, R4, and R5 Rescue Helmets. The ESS X-tricator™ can be stored in a pocket and deployed using the Snap-On/Snap-Off™ helmet mount system, providing the performance of an ESS goggle in seconds. Includes a set of two Tear-Off Lens Covers.

481539G Xtricator Goggles



### Vertex® Best Helmet for work at height and industry.

The adjustment wheel has two height positions and the chin strap can be adjusted for a perfect fit. Side slots and the above-the-ears cut of the shell allow attachment of standard hearing and eye protection. Four clips, on the outside the helmet, correctly hold a headlamp. Polycarbonate shell, resistant to impact and wear. Weight: 492 gms. Meets CE and ANSI Z89.1 - 2003 -Type I class E.

235410202	Yellow
235410204	Red
235410209	White
235410201	Black



### Vertex® Vent

Comfortable and durable helmet with ventilation, meets requirements for working at height. Adjustable ventilation: 5 holes on each side, can be closed with 2 sliding shutters. Chin strap designed to decrease the risk of losing the helmet in case of impact during a fall. Polycarbonate shell, resistant to impact and wear (meets EN 397 industrial helmet standard and EN 12492 standard). Meets optional requirements of the EN 397 standard: lateral deformation and use at low temperatures (down to - 30 °C). Weight: 465 gm Meets CE and ANSI Z89.1 - 2003 -Type I class C.

235410252	Yellow
235410254	Red
235410259	White
235410251	Black



Shown on Cascade Water Rescue Helmet (not included)

### ESS StrikeTeam Goggles

Designed for Technical Rescue and Wildland Fire Fighting equipped with a thick polycarbonate lens that has been hardcoated and anti-fog treated both inside and out. Soft open cell facefoam designed to fit over most eye glasses. Comes with flame resistant Velcro™ tabbed elastic strap which features instant fit speed clip. Exceeds ANSI Z-87.1 and CSA Z94.3-92

481601	StrikeTeam XTO
481609C	Replacement Lens, Clear
481609S	Replacement Lens, Smoke
481608	Tear Off Lens Covers
480555	Goggle / Headlamp Clip



235410239

### Vertex® Best DUO LED 14 Helmet integrated DUO LED 14 Headlamp

Tilt-able hybrid light source : halogen and 14 LEDs. Halogen light source for long distance lighting (100 m). Regulated 14 LED lighting : maintains constant level of lighting for up to 63 hours. Meets CE and ANSI Z89.1 - 2003 -Type I class C. Color: White Only.

Vertex w/ Duo LED 14



Shown w/ R5 Rescue Helmet (not included)

### Mini Q-4 Helmet Light Fits Kiwi Light Pods

Extremely bright! Over twice as bright as premium lights of similar size. Provides 4 AA Batteries of power in a light approximating the size of lights containing only 2 AA batteries. Comfortably fits in pocket, briefcase, tool box, and other small places. Optional Helmet mounting brackets attach to industrial, fire, and climbing-style helmets. Burn Time 4-5 hours. Dimensions: 5.5" x 1.5" x 1" . Batteries included. FM Approved. Weight: 6.3 oz.

485342	Mini Q-4 Fire (YE)
485349	Spare Bulb for Mini Q-4





### Tikka Plus

Adjustable proximity lighting with long burn time. Three lighting levels (maximum, optimum, economy) and a blinking mode. Ergonomically designed, comfortable elastic headband. Tilting lamp body. Long light duration up to 150 hours. Water-resistant for all-weather use. Uses 3 AAA/LR03 batteries (supplied). Weight: 78 gm including batteries.

235405472 Tikka Plus



### MYO XP

The Petzl Myo XP is the newest light from Petzl. It features a single high-powered LED with 3 lighting levels. Provides a powerful, even and adjustable white light, with long duration. It is a single light for multiple uses. Powerful, focused light beam with 3 lighting levels (maximum, optimum, and economy) and a blinking mode, to adapt the light to the activity and as a function of light duration needs. "Boost" mode provides 50% more light than the maximum level for 20 seconds. Wide angle, flip-down, lens is included for flood beam like proximity lighting. Battery life indicator to warn when the batteries are 70% and 90% drained. Tilt-able light body. Switches are protected to help avoid accidental operation. Water resistance for all-weather use. Lighting distance of up to 45 meters (65 meters in boost mode). Light duration of up to 170 hours. 3 AA batteries (included) Weight: 175 grams with batteries.

23542083 Myo XP



### Tikka XP / XP HazLoc

The Petzl Tikka XP is the newest light in the Petzl Tikka series of headlamps. Using one high powered LED this light is brighter than the 4 LED's found in the Petzl Tikka Plus light. Using a new high power focused LED light output will have three settings plus a 'boost' button producing a 50m beam when required. Other features include a tilting head, sliding diffuser for flood lighting and an LED battery level indicator. Includes a boost setting: (50m range) 20 second before reverting to previous setting. Light Duration: High: 60h; Medium: 80h; Low: 120h. 3 x AAA(included). HazLoc Model Rating: UL Class I, Div2, Group C,D.

Weight with batteries: 95 grams.

23542086 Tikka XP  
23542081 Tikka XP HazLoc (shown)



Helmet not included.

### e+LITE

#### Emergency headlamp

Long-term dependability, even when kept for years in harsh conditions - can be stored with batteries for up to 10 years and still be operational. Waterproof down to -1 m. Protective case included. Shines up to 19 m and provides up to 4 consecutive nights of lighting (45 hours).

Can be worn on the head, around the wrist or neck or attached to thin-edged objects with integrated clip. Red light beam helps preserve night vision. Clip attachment system and removable elastic headband. Certified ATEX (3 GD EEx nl IIC T6) and HazLoc

Technical specifications

- 3 white LED and 1 red LED.
- Waterproof down to -1 m.
- Weight : 27 g with batteries.
- 10-year guarantee.

23542121 e+LITE



### Heads Up Lite

#### Watertight to 500 Feet

Adjustable beam with large on/off switch. Corrosion proof ABS polymer. 4 AA-cell Alkaline Batteries included. Heat resistant hypo-allergenic silicone rubber strap. Head rotates up and down - special ratchet system holds light in place. Ideal for hard hats and helmets. Includes one high and one low intensity krypton lamps. Color: Black. Weight: 5.4 oz.

4872600RS Heads Up Lite

UL approved intrinsically safe, CL I, Div. 2, Group ABCD, T3C)

**▲ WARNING**

Technical rescue and safety is potentially hazardous. Any person using equipment sold by RESCUE TECHNOLOGY in any manner is personally responsible for learning the proper techniques involved, and assumes all risks and accepts full and complete responsibility for any and all damages or injury of any kind, including death, which may result from the use of any RESCUE TECHNOLOGY equipment.



### Heads Up Dual

#### Xenon / LED Combination

The Dual combines Pelican's bright Xenon headlamp with a long-lasting set of three (3) LED lamps. Switch controls Halogen and LED lamps. Tilt head offers 90° adjustment. Runs on 3 AA-cell batteries (included). Runs 3 hours on the halogen lamp and 50 hours on the LEDs. Complete with rubber strap. Color: Black. Weight: 4.9 oz.

4872620RS Heads Up Dual

UL approved intrinsically safe, CL I, Div. 1, Group CD, T3C)





### EOS II LED

The EOS is optimized for both close-up and distance needs. The combination of a Luxeon/1 watt L.E.D. and a special lens maximizes the beam by balancing long throw with flood light. The EOS provides a self-contained 3AAA battery system that eliminates external wires, and is equipped with (3) brightness levels. Each level provides true current regulation ensuring that the EOS will remain at constant brightness as long as the batteries have sufficient voltage. Durable and water resistant to water. Weight: 3.7 oz with Batteries (Included). Waterproof to 1 Meter. Burn Time: High: 6.5 Hours; Medium: 12.5 Hours ; Low: 60 Hours.

21851051 EOS II LED  
2185105 EOS LED

UL approved intrinsically safe, CL I, Div. 2, Group ABCD



### Apex LED

The Apex LED Headlamp will light up your Rescue world. The 3-watt MaxBright LED will shine a spotlight beam up to 180 feet away and the four Ultra-bright LEDs will cast a steady wide beam or flashing light out as far as 75 feet. All this power in a 10-oz. package that squeezes 72 to 200 (average 150) hours of light out of four AA alkaline batteries (included). Waterproof to 1 Meter. The dual switch design allows easy access to the five modes. Submersible to 3-feet, works with alkaline, lithium or rechargeable batteries. Burn Time: 3-watt MaxBright LED

High Mode - 72 hrs  
Low Mode - 96 hrs

Burn Time: Four Ultra-bright LED's  
High Mode - 100 hrs  
Low Mode - 150 hrs  
Flashing Mode - 200 hrs

2185101 Apex LED

UL approved intrinsically safe, CL I, Div. 2, Group ABCD, T3C)



### Yukon HL Headlamp

Hybrid L.E.D. Technology employs state of the art, 1-watt L.E.D. and 3 high output, 5mm L.E.D.s. The 1-watt L.E.D. rivals the output of incandescent bulbs. For long burn time switch to the 3 L.E.D. array. 10,000 hour bulb life and burn times of 44 hours from the 1-watt L.E.D. and 120 hours from the 3 L.E.D. array.

488145HL Yukon HL Headlamp

UL approved intrinsically safe, CL I, Div. 1, Group ABCD, T3C)

**▲ WARNING**  
Technical rescue and safety is potentially hazardous. Any person using equipment sold by RESCUE TECHNOLOGY in any manner is personally responsible for learning the proper techniques involved, and assumes all risks and accepts full and complete responsibility for any and all damages or injury of any kind, including death, which may result from the use of any RESCUE TECHNOLOGY equipment.

RESCUE TECH

www.rescuetech1.com



### Quad Headlamp

Four Ultra-bright LEDs power through the darkest conditions. Tough waterproof housing that will survive severe impacts and water submersion up to one meter. Four LED bulbs operate in high, medium, low and flashing modes. Battery power meter with 24 hour burn time on high setting and 47 hour burn time on low setting. Water proof to one meter.

2185201

UL approved intrinsically safe, CL I, Div. 2 Group ABCD  
UL approved intrinsically safe, CL 2 Div. 2, Group FG



### Aqua King NEMO

Watertight to 500 feet. 12 volt, 14 watt, 100,000 candlepower, primary hand-held light source. ABS housing with high impact polycarbonate lens. Includes dual filament Xenon safety lamp with 60 hours of lamp life (30 hours each), protective lens shroud, and a shock absorbing internal battery module that protects 8 D-cells from hard abuse. Combination pistol / lantern grip quickly converts to multiple positions. Operates 10 - 12 hours on 8 D-cell alkaline batteries (not included). Dimensions: 9" x 4.5". Color: Black. Weight: 2.7 lbs.

4874000 Aqua King NEMO  
4874003 Xenon Lamp Module  
4874006 Wall Mount Bracket

FM, CSA approved non-incendive.



### Princeton Tec Pilot

A great extra light source, the Pilot weighs only 15 grams. Attaches to headlamp straps, harnesses, belts, backpack and hydration pack straps. The Pilot is always accessible for use as a hand held light or marking light with the included blinking/signaling mode. It features:

- High Powered white L.E.D.
- Burn Time: 12-14 Hours
- Water-resistant
- Made in USA
- Lifetime warranty

21851081 Black w/ White LED  
21851084 Red w/ Red LED  
21851085 Green w/ Green LED





**Super SabreLite**  
*Industrial Quality Work Light*



Used by Army and Navy strike teams. High-tech Xenon Laser Spot provides four times the useable candle power of ordinary C & D size flashlights. Unbreakable ABS body with a high impact polycarbonate lens. Includes belt spring clip, stainless steel split ring and black lanyard. Meets Military specifications. Requires 3 C-cell batteries. Dimensions: 7.75" x 1.875. Weight: 6.5 oz.

48720001	Black
48720000	Orange
48720002	Yellow
4872004	Xenon Lamp Module

*UL Class 1, Div. 1 Approved. FM, MSHA, CSA, AUS, and USAR approved non-incendive.*

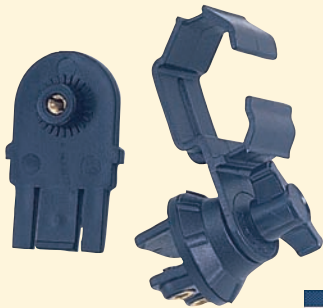

**Helmet Lite Holder**

Multi-directional adjustable light holder. Three piece set designed to fit all hard hats and fire helmets without drilling or gluing. Attaches to either left or right side and does not interfere with visors. Fits VersaBrite, VersaBrite II, Mitylite and Stealthlite and Mini Q-4.

4870700	Polycarbonate
4870760	Stainless Steel



**StealthLite**

Watertight to 500 feet. Unbreakable ABS body with high impact polycarbonate lens. State of the art Laser Spot Xenon lamp module. Includes one-handed safety switch operation, double shock mounted battery compartment, and black lanyard. Operates 5 - 6 hours on 4 AA-cell alkaline batteries (not included.) Weight: 5.3 oz.

48724001	StealthLite (Black)
48724002	StealthLite (Yellow)
4872404	Xenon Lamp Module

*FM, CSA, USAR approved. Class I, Div. I, Group D.*



**Little Ed™ Rechargeable Recoil LED™**

The Recoil uses a 1 watt LED that's aimed backwards into the reflector. 100% of the light is captured and aimed forward as a tight collimated beam that's as bright as an incandescent. The body is made of tough ABS resin that's corrosion proof and resistant to extreme temperatures. It uses a long-life NiMH battery pack for extended burn time and comes with a charger base unit that can be installed at home or work using the 110V transformer. Packaged Weight: 1.7 lbs.

48736602



**FoxFury**  
**Performance Fire Headlamp**  
*For Helmets with Visor*

Powerful 24 LED Headlamp with Ultra-bright LED's and an Adjustable Beam Angle. Meets NFPA Fire Resistant Requirements of 500°F (260°C) for 30 minutes. Intrinsic Version Is ideal for Fire Resistant light for Hazardous Environments including Structural Firefighting, Chemical Plants and HazMat. The only headlamp in the world that is UL 913 Certified Intrinsic Safe for Hydrogen and Acetylene Environments.

- Provides Distance and Peripheral Vision
- Helps cut through smoke and fog
- Fits Most Helmets with Visors or Shields
- 4 Ultra-bright LEDs for Focused Vision

23874006	Standard
23874016	Intrinsic

*Intrinsic version meets:  
Class 1, Division 1 Groups A-D, T6  
Class 1, Division 2 Groups A-D, T6*



**FoxFury**  
**Signature Fire Headlamp**  
*Fits Helmets without a Face Shield*

Meets NFPA Fire Resistant Requirements--500°F (260°C) for 30 minutes. Fire Resistant Headlamp with Peripheral Lighting Designed for Structural Fire Fighting as well as Wildland Fire Fighting. Intrinsic Version is ideal as a Fire Resistant light for Hazardous Environments including Structural Firefighting, Chemical Plants and HazMat.

- Autodim Sensors
- 4 AA (Batteries Not Included)
- Battery Life:
  - Full Power = 8 hours
  - Reserve = 16 hours
- Distance Vision = 100 - 150 ft
- Peripheral Vision = 60 ft
- Weight = 11.9 oz
- Size = 7.4" x 1.3" x 3.0"
- Waterproof to 20 ft.

23872006	Standard
23872016	Intrinsic

*Intrinsic version meets:  
Class 1, Division 1 Groups A-D, T6  
Class 1, Division 2 Groups A-D, T6*





Clip for windows and cones

## E-Flare™ 500

E-Flare 500 Series: Professional HZ Model

- Rubber Base Included
- Flouro Yellow Body Color
- Bright Clear Colors.
- Low Battery Indicator
- Designed for use in Class I, Div 2/Zone 2 Hazardous areas
- 80 hour battery life

23625004	E-Flare, Red
23625002	E-Flare, Amber
23625006	E-Flare, Blue
2362500C	Mounting Clip
2362500M	Mounting Bracket, Magnetic

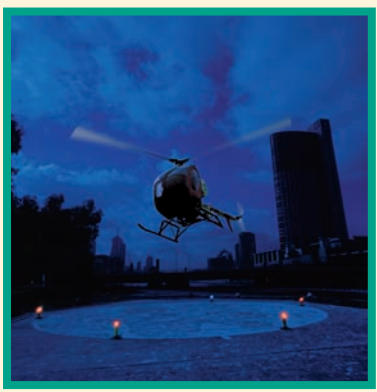

Shown: LZ Kit, Red/Blue

## E-Flare™ 5 Strobe LZ Kit

E-Flare 500 Series: Professional Model

- Rubber Base Included
- Flouro Yellow Body Color
- Bright Clear Colors
- Low Battery Indicator
- Designed for use in Class I, Div 2/Zone 2 Hazardous areas
- 80 hour battery life
- 5 Strobe LZ Kit includes 1 Blue and 4 Amber or Red Strobes.

23625100	E-Flare LZ Kit, Amber/Blue
23625104	E-Flare LZ Kit, Red/Blue



## Lite Tracker™ Great for RIT Kits

LITE TRACKER™ is a bright flashing visual indicator which ensures that the wearer can be seen at night or in low visibility conditions. This small, lightweight device is made of tough polycarbonate plastic, making it virtually indestructible.

- Super Bright L.E.D. Provides Strobe
- Tough Polycarbonate Case
- No Bulbs To Break
- Over 50 Hours at full intensity brightness

2252304	Light Tracker (Red)
2252302	Light Tracker (Lime)



## RescueTECH ACCESS Lifeline™ T-Shirt

After receiving many requests, we finally added a T-shirt to our promotional line of products. Made from 100% cotton, the shirt is both comfortable and durable. Color: Heather Gray.

400229	Small
400239	Medium
400239	Large
400239	XLarge
400239	XXLarge

## Swiftwater Rescue

An in-depth look at swiftwater rescue for the professional. Topics include basic rescuer safety considerations, river hydrology, equipment, shore-based, boat-based, and in-water rescue techniques, medical considerations, rigging for river rescue, incident command, and swiftwater training. Illustrated with line drawings and photographs. Paperback. 360 pages.

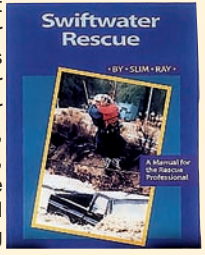

899122 Swiftwater Rescue

## Swiftwater Field Guide Companion to Swiftwater Rescue

Handy 4" x 6" pocket reference to topics like basic rescuer safety, river hydrology, equipment, shore-base, boat-based, and in-water rescue techniques, knots, rigging for river rescue, helicopters, incident command, and special situations. 52 pages.

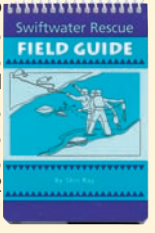

899124 Swiftwater Field Guide

## Whitewater Rescue Manual

This book presents the best techniques for self-rescue and rescue of companions on the river. Subjects include equipment safety, rope handling skills, swimming rescues, and first aid. Exciting case histories are interlaced as sidebars to the running text. 256 pages. 120 illustrations.

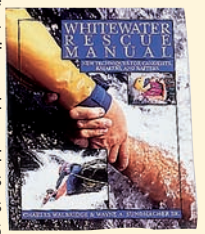

899121 Whitewater River Rescue

## Z-Drag Crib Sheet

Durable plastic "crib sheet" is a handy reference when you need to rig a quick 3:1 mechanical advantage system. They show how to set up a Z-Drag, Vector Pull, C+Z, Double Z. Also includes important knots. Dimensions:



899116 Z-Drag Crib Sheet



## Public Safety Diving By Hendrick and Zaferes

Written for instructors, dive team captains, surface teams, and underwater personnel. Offers information on procedures for safe operations and proper methods of training. Safety is the consistent theme throughout, with an emphasis on surface support, accident prevention, contingency procedures, and standard operating guidelines. Includes methods of search in Black Water, Swiftwater, and Contaminated Water.

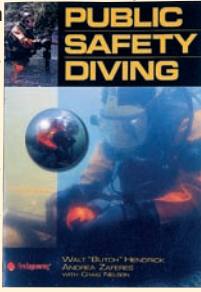

899130 Public Safety Diving

## Surface Ice Rescue By Hendrick and Zaferes

This book provides practical, up-to-date information on training, team management, equipment, and techniques for ice rescue teams.

- Preplanning
- Three levels of training
- Managing an operation
- Ice rescue equipment
- Duties and responses
- Communication
- Special situations
- The four processes of heat loss

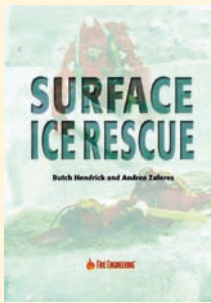

200 pages. Dimensions: 7" x 10"

899134 Surface Ice Rescue

## Technical Rescue Operations Volume I

### Planning, Training & Command

The new rules of rescue have improved the way firefighters and other first responders are able to detect, locate, treat, and extract trapped victims in practically any situation by emphasizing factors like innovative training, better equipment, and more intelligent planning by well-informed decision-makers. Technical Rescue Operations, Volume I: Planning, Training, and Command lays the framework for responding to technical rescues and disasters of all types in the safest and most effective manner.



899132 Technical Rescue Ops I

## Technical Rescue Operations Volume II

### Common Emergencies

The second in a 3-volume series covers responding to, managing, and conducting rescues in the "daily" setting of fire/rescue agencies. This volume explains how to handle more complex and large-scale rescue operations that challenge responders to apply solid rescue principals for longer periods of time, with the assistance required of additional resources and under more strict command and control because of the scope of the incident, its newsworthiness, crowds of people arriving on the scene, and getting the immediate attention of local or regional elected officials.



899133 Technical Rescue Ops II

## Engineering Practical Rope Rescue Systems by Mike Brown

The NEW Standard by which all technical rope texts will be judged. Thoroughly researched, comprehensive, and easily understood. Covers everything from forming and training a rescue team to traverse engineering.

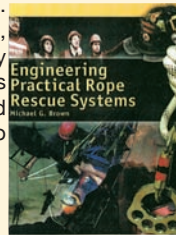

899104 Engineering Rope Rescue Sys.  
899104G Instructor's Guide

## High Angle Rescue Techniques 3rd Edition

A textbook style publication that is designed to teach rope rescue techniques in a systematic manner. Step-by-step approach, full color text makes it easy to learn. Includes planning for an incident, managing a team, troubleshooting problems, operating equipment, and much more. Primarily written from a search and rescue point of view. 407 pages. Hundreds of Photos and illustrations. Includes handy Field Guide. Dimensions: 8.5 x 11".



899107 H.A.R.T.  
899107G H.A.R.T. Field Guide

## Staying Alive: Swiftwater Rescue Techniques - DVD

This video can be used as a training aid or as a great addition to your reference library. It contains the latest in rescue techniques, with many live footage scenes & actual rescues. Perfect for the first responder all the way up to Technical Rescue Professionals. Includes: rescue basics, gear, hydrology, river features, rescue scene management & incident size up, self rescue, and more. Also knots, anchors, lowhead dam rescue, foot entrapment & PFDs

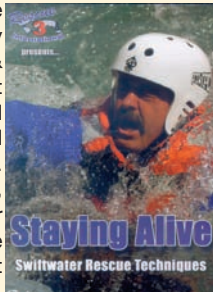

899521

## Swept Away

### Video Guide to Water Rescue Op's

A comprehensive rescue training film that has been specifically developed for emergency personnel who are called upon to respond to water emergencies. Swept Away provides an in-depth look at the essentials of water rescue and can serve as an invaluable training resource for both new and experienced emergency personnel. Running Time: 30 Minutes.



899520 Swept Away

## On Rope - 2nd Ed.

Excellent reference for those interested in single rope techniques. Written from a recreational point of view, it is nonetheless comprehensive and very informative. Contains large glossary of rope work terms and describes rappelling, ascending, and other techniques. Dimensions: 8.5 x 11".

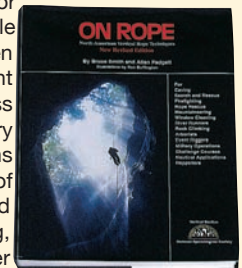

899108 On Rope



## Confined Space Rescue

by Chase Sargent

Bridges the gap between theory and practice. A comprehensive guide to hazardous atmospheres, detection equipment, breathing apparatus, ventilation, retrieval systems, backup teams, and operational procedures. Covers: Forming a Team, Planning, Training, Equipment, Command, Response, Entry & Rescue, and much more... 244 pages.



899112 Confined Space Rescue

## Confined Space Rescue

by Browne / Crist

A complete text that focuses on confined space operations from hazard recognition to rescue operations. Explains hazards of confined spaces and integrating ICS into the rescue operation. Nine step process with checklists simplifies the toughest rescue operations. Case studies and real life examples. 204 pages.



899131 Confined Space Rescue  
899131G Instructor's Guide

## Confined Space and Structural Rope Rescue

The complete guide for technical rescue from man-made confined spaces and industrial environments. Covers all aspects of rescue operations. Topics include team development, rigging and hauling techniques, and hazard reduction and compliance issues. 384 pages, 200 illustrations. Dimensions: 8.5 x 11".



899118 Confined Space & Structural Rope Rescue

## Technical Rescue Field Operations Guide

by Tom Pendley

Contains over 150 high quality graphic illustrations, command checklists, and easy to follow, step-by-step procedures for rope rescue, confined space rescue, swiftwater rescue, trench rescue, structural collapse rescue, and helicopter rescue. Dimensions: 4" x 6.5".



899120 Technical Rescue Op's Guide

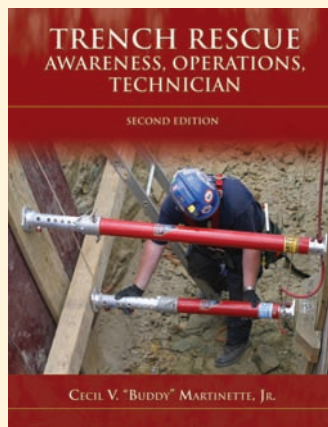

## Trench Rescue: Awareness, Operations, Technician, 2nd Ed.

The most comprehensive textbook ever published on rescue operations in trench emergencies. Author C.V. "Buddy" Martinette covers everything from basic concepts of risk benefit to practical procedures for technician-level trench protective systems. The Second Edition includes current information on trench tools and equipment, PPE, rescue system preparation, types of collapse, hazard control, and more. The text includes up-to-date coverage of Trench Rescue Sections of NFPA 1670, NFPA 1006, and OSHA CFR § 1926 Subpart P, Excavations. The Second Edition now helps students make more effective use of class time by providing printed PowerPoint slides directly within the text.

899140 Trench Rescue, 2nd ed.  
899141 Operational Field Guide

## WARNING

Technical rescue and safety is potentially hazardous. Any person using equipment sold by RESCUE TECHNOLOGY in any manner is personally responsible for learning the proper techniques involved, and assumes all risks and accepts full and complete responsibility for any and all damages or injury of any kind, including death, which may result from the use of any RESCUE TECHNOLOGY equipment.

## Technical Rescue Riggers Guide

Contains dozens of illustrations and photographs to use as a quick reference for modern rope rescue techniques. This handy guide displays pulley systems, tandem prusik belays, knots, bends, hitches, litter packaging, and much more. Note: This is not an instructional text, but rather a quick reference guide for trained personnel. Dimensions: 4" x 6".



899123 Technical Riggers Guide



## Trench Rescue DVD

The Trench Rescue DVD contains real-life footage demonstrating the practical procedures discussed in the Trench Rescue text. The DVD, which covers both Operations and Technician level skills, shows students how to successfully perform each skill and offers helpful information, tips, and pointers.

899145 Trench Rescue DVD

## Trench Rescue

A must read for those in trench rescue situations, this vital new resource demonstrates a systematic approach to safely and successfully carrying out a trench rescue operation. 258 pages. Over 300 step-by-step photos. Dimensions: 8.5 x 11".



899119 Trench Rescue

## The Morrow Guide To Knots

A MUST book for those interested in tying or teaching knots. Excellent directions for tying nearly all useful knots. Sections on cordage, utility knots, hitches, tackle, and decorative knots. 259 pages, over 600 photographs. Dimensions: 7.5 x 5".



899105 Morrow Guide To Knots

## ORDERING INSTRUCTIONS

1. Use catalog numbers and descriptions. This will help us correctly and promptly fill orders.
2. Remember to indicate size, color, and length, where applicable.
3. We ship UPS but will mail parcel post or utilize motor freight at the request of our customers.
4. Order line: 800-334-3368, for information call (770) 832-9694. FAX (770) 832-1676.
5. Our office hours are 9:00 a.m. - 5:00 p.m. (eastern). FAX operates 24 hour per day.

NOTICE: By placing an order the customer acknowledges agreement with the terms and conditions stated below, and acknowledges having read and understood the important warnings in this catalog. The customer further agrees that the laws of the state of Georgia shall apply to the purchase or any dispute arising therefrom.

## SHIPPING INFORMATION

All products are sold F.O.B. shipping point. Shipping charges for retail customers inside the U.S. will be approximately 7% of merchandise cost: \$7.00 minimum. A \$7.00 charge will be added to COD shipments. A handling charge will be added to all shipments to cover insurance and carrier accessorial charges. Single items weighing over 70 lbs. will be shipped via most cost effective method.

## PAYMENT POLICY

Purchase orders are accepted from government agencies, cities, and municipalities. Business and volunteer organization purchase orders are accepted if an open account has been approved by our credit department. All orders from individuals require Visa, Mastercard, COD, or check with order. Please allow time for your check to clear your bank. Prices are in U.S. dollars and are subject to change without notice. Sales tax is added to all orders shipped to Georgia addresses. Billing discrepancies must be reported within 10 days of invoice date. Returned checks subject to \$30.00 fee.

## DAMAGED SHIPMENTS

If the shipping container is damaged, immediately open the carton and inspect the contents. Damaged shipments should be reported to the carrier immediately and not returned until instructions are received. DO NOT return the goods to us unless you have received a return authorization.

## INTERNET ACCESS

Rescue Technology is accessible via the internet. You may E-Mail directly to:

[info@rescuetech1.com](mailto:info@rescuetech1.com)

Please look at our New Web site for latest product information:

<http://www.rescuetech1.com>



We proudly display this flag to designate equipment that is made in the U.S.A.

Copyright July 2008.  
Rescue Technology  
Carrollton, GA 30117  
All rights reserved.

## WARNING

Technical rescue and safety is potentially hazardous. Any person using equipment sold by RESCUE TECHNOLOGY in any manner is personally responsible for learning the proper techniques involved, and assumes all risks and accepts full and complete responsibility for any and all damages or injury of any kind, including death, which may result from the use of any RESCUE TECHNOLOGY equipment.

## RETURNS

Please call customer service at 770-832-9694 for a Return Authorization Number before returning any merchandise. Freight on returns must be paid by the purchaser. Absolutely no returns on "less than spool" or open stock quantities of rope or webbing products or custom/ special order / non-stock items unless the item was received in a damaged condition. A sized product may be exchanged for a different size if the returned item is in a re-sellable condition. Any return that is due to a customer error is subject to a 15% re-stocking fee. Any eligible return will be credited only after a full inspection of the product is completed.

## UNCONDITIONAL GUARANTEE

All merchandise offered in this catalog is returnable (in new condition) within 10 days, for any reason, for full refund credit less original shipping costs. CALL FOR RETURN AUTHORIZATION. Excludes cut lengths of rope or webbings and custom or special order products.

## LIMITED WARRANTY

RESCUE TECHNOLOGY warrants to the original purchaser that products manufactured and/or sold by RESCUE TECHNOLOGY will be free from defects in materials and workmanship. This expressed warranty and all implied warranties imposed by law are limited to one year duration from the date of purchase. RESCUE TECHNOLOGY will repair or replace any product returned under warranty if, in RESCUE TECHNOLOGY's judgment, the product has not been misused or altered. No further warranties exist or are implied by RESCUE TECHNOLOGY due to the high risks involved in rescue services and in outdoor activities such as, but not limited to, mountaineering, rock climbing, rappelling, or caving, which can be reduced only through the skill, training, and judgment of the individual participant. RESCUE TECHNOLOGY shall not be liable for any and all consequential damages arising out of the breach of the expressed or implied warranties on sales by RESCUE TECHNOLOGY products. This limited warranty in no way limits or alters other manufacturers' warranties on products that are sold or distributed by RESCUE TECHNOLOGY.

NOTE: Some states do not allow limitation on how long an implied warranty lasts nor the exclusion or limitation of incidental or consequential damages, so the above limitations may not apply.

## PRODUCT MODIFICATIONS

RESCUE TECHNOLOGY reserves the right to modify, without notice, the specifications and price of products described in this catalog and the terms of sale.

### RescueTECH Trademarks

Rigger, RT Rescue, Quadlock, ACCESS Lifelines, EGRESS Escape Rope, EGRESS-Hybrid Escape Rope, EGRESS-Nylon Escape Rope, PROBE Search Rope, PROBE-R Search Rope, PROBE-Hybrid Search Rope, PROBE-Nylon Search Rope, CORONA Escape Belt, VANGUARD Rescue Harness are trademarks of Southeastern Safety Products, Inc. d/b/a RESCUE TECHNOLOGY.

### Other Trademarks

A.T.E.P. is a trademark of Rescue Systems, Inc. Kevlar® and Nomex® are registered trademarks of E.I. DuPont Co.

